



**ENTORNO  
INDUSTRIAL**

**NEW**  
Star Halo® LED Beacons

# STAR WARNING SYSTEMS®



*D.O.T. • UTILITY • SECURITY • CONSTRUCTION*



# Thank you to all of our customers for our continued success.

I purchased the company from my father at the end of 2008. I would like to take this opportunity to thank my father for helping to grow our company to where it is today. I want to assure you that Star will continue to be family owned for another generation.

I am proud to be a 5th generation President of a company that continues to be the largest manufacturer of amber lights to the heavy duty truck market in the United States. With some of the new LED products you will see in this new catalog, we have only added to the innovative lighting design you are accustomed to seeing from Star.

Star also achieved the ISO 9001:2008 certification in our production facility and are proud to be the largest American made amber lighting company today. We are a fully functional vertically integrated company.

On the back cover we have a picture of our dedicated employees from our 120 year anniversary. We are proud to have such a wonderful and hard working group of individuals dedicated to making us #1.

Of course none of this would be possible without reliable and dedicated customers such as yourself that make our progress as a company possible, and we thank you for your continued support and loyalty.

As you look through our new catalog, please give us a call, and one of our dedicated customer service people will be glad to answer all of your questions. Please also don't forget to check our new website [www.starheadlight.com](http://www.starheadlight.com), for the most up to date information and products that we offer.

*Christopher D. Jacobs*  
President





# TABLE OF CONTENTS

Star Halo® LED Beacons _____	2-6
Compact LED Beacons _____	7
Strobe Beacons _____	8-15
Revolving Beacons _____	16
Dash Lights & Accessories _____	17
Flashing Beacons _____	18-19
LED Lights _____	20-25
Remote Kits & Heads (LED & Strobe) _____	26-30
Traffic Directors _____	31-33
Star Phantom® Series _____	24, 34-35
Star Mini-Bars® (LED, Strobe & Halogen) _____	36-39
Star Laser® Lightbars _____	40
Star Razor® Lightbars _____	41-42
Star Sabre® Lightbars _____	43-45
Star Interceptor® Lightbars _____	46-47
Aerostar® Lightbars _____	48-52
Starbar® Lightbars _____	53-54
Star Alarm® Back-up Alarms _____	55-56
Switch Panels & Switch Boxes _____	57
Starflash™ Flasher Modules & Heads _____	58
Accessories _____	59-61
Specifications _____	62-66
Star Lightbar Hook Mount Kits _____	64
Strobe Tube & Bulb Guide _____	67
Numerical Index _____	68

Due to continuous product improvement programs, we must reserve the right to change specifications and information at any time without prior notification.

## ENTORNO INDUSTRIAL, S.A. DE C.V.

Juan Sarabia No. 205, Col. Nueva Santa María, 02800 México, D.F.  
Tels.: (55) 5356-7206 • Fax: (55) 5356-7209  
e-mail: ventas@entorno-industrial.com • direccion@entorno-industrial.com

www.entorno-industrial.com







STAR Halo® LED technology is a patent pending, extremely low current draw, ultra high intensity LED light that exceeds the latest J845 and CA13 standards. The circuitry is designed with 24 customer selectable flash patterns, high/ low intensity feature (Manual or Automatic), and S-Link System™ that allows synchronizing capabilities with other STAR LED products. Circuitry is fully encapsulated for increased weather and shock resistance. Choose from several different beacons that incorporate STAR Halo™ LED technology.

## 200AH8L & 200AHL SERIES



**200AHL Series**

**Models:**

- 200A1H8L:** SAE Class I, California Title 13, Ultra High Intensity STAR Halo® LED Optics, 1" Pipe Mount
- 200AH8L:** SAE Class I, California Title 13, Ultra High Intensity STAR Halo® LED Optics, Permanent Mount
- 200A1HL:** SAE Class I, High Intensity STAR Halo® LED Optics, 1" Pipe Mount
- 200AHL:** SAE Class I, High Intensity STAR Halo® LED Optics, Permanent Mount

**Specifications:**

- Heavy-duty spun aluminum base and universal mounting: permanent mount, universal mount plate with 1" pipe mount
- Durable polycarbonate inner lens and outer dome
- Clear, smooth, outer dome for easy cleaning and provides inner lens protection

- Dimensions:** 7-3/4" tall x 9" dia., 4 lbs.
- Voltage:** 12V-24V DC
- Amp Draw:** 0.6 Amps @ 12V DC, 0.3 Amps @ 24V DC
- LED Colors:** Amber, Blue, Red, White
- Lens Colors:** Amber, Blue, Clear, Green, Red
- Approvals:** SAE Class I (Amber)  
(Does not apply to all flash patterns)

## 200BH8L & 200BHL SERIES



**200BHL Series**

**Models:**

- 200BH8L:** SAE Class I, California Title 13, Ultra High Intensity STAR Halo® LED Optics, Permanent Mount or 3/4" Pipe Mount
- 200BHL:** SAE Class I, High Intensity STAR Halo® LED Optics, Permanent Mount or 3/4" Pipe Mount

**Specifications:**

- Heavy-duty spun aluminum base and universal mounting: permanent mount, standard 3/4" pipe mount
- Durable polycarbonate inner lens and outer dome
- Clear, smooth, outer dome for easy cleaning and provides inner lens protection

- Dimensions:** 6-7/8" tall x 8-1/4" dia., 4 lbs.
- Voltage:** 12V-24V DC
- Amp Draw:** 0.6 Amps @ 12V DC, 0.3 Amps @ 24V DC
- LED Colors:** Amber, Blue, Red, White
- Lens Colors:** Amber, Blue, Clear, Green, Red
- Approvals:** SAE Class I (Amber)  
(Does not apply to all flash patterns)



## 258HTDCL & 258HTDSL SERIES



258HTDCL/258HTDSL Series



**Cig Plug**  
includes Pattern  
Select and On/  
Off Switches

Halo DC™ features the first “full image” dual-color warning beacon. Halo DC™ allows you to change from an amber beacon to a blue beacon with the flip of a switch. Other color combinations available.

### Models:

<b>258HTDAL:</b>	tall lens w/Dust Cover
<b>258HTDCL:</b>	tall lens
<b>258HTDSL:</b>	short lens
<b>258HTDALV:</b>	tall lens w/Dust Cover and vacuum magnet mount
<b>258HTDCLV:</b>	tall lens w/vacuum magnet mount
<b>258HTDSL V:</b>	short lens w/vacuum magnet mount

### Specifications:

- **Dimensions:**
  - (Short Dome): 4-3/4" tall x 6-13/32" dia.
  - (Tall Dome): 6-11/16" tall x 6-13/32" dia.
- **Voltage:**
  - (permanent mount): 12-24V DC
  - (vacuum magnet mount): 12V DC
- **Amp Draw: 0.7 Amps @ 12V DC, 0.35 Amps @ 24V DC**
- **Lens Colors: Clear**
- **LED colors: amber/blue, amber/red, amber/white, red/green and red/white**
- **Approvals: SAE Class I (amber/blue)**
- **S-Link System™ - hardwired models**

## 251H8TL & 251HTL SERIES



251H8TL/251HTL Series

STAR Halo® LED technology is a patent pending, extremely low current draw, ultra high intensity LED light that exceeds the latest J845 and CA13 standards. The circuitry is designed with 24 customer selectable flash patterns, 2 rotating patterns high/ low intensity feature (Manual or Automatic), and S-Link System™ that allows synchronizing capabilities with other STAR LED products. All circuitry is fully encapsulated for increased weather and shock resistance. Choose from several different beacons that incorporate STAR Halo® LED technology.

### Models:

<b>251H8TAL:</b>	Ultra High Intensity LEDs and tall dome with dust cover
<b>251H8TCL:</b>	Ultra High Intensity LEDs and tall dome
<b>251H8TSL:</b>	Ultra High Intensity LEDs and short dome
<b>251H8TAL-BG:</b>	Ultra High Intensity LEDs and tall dome with dust cover and branch guard
<b>251H8TCL-BG:</b>	Ultra High Intensity LEDs and tall dome and branch guard
<b>251H8TSL-BG:</b>	Ultra High Intensity LEDs and short dome and branch guard
<b>251HTAL:</b>	High Intensity LEDs and tall dome with dust cover
<b>251HTCL:</b>	High Intensity LEDs and tall dome
<b>251HTSL:</b>	High Intensity LEDs and short dome
<b>251HTAL-BG:</b>	High Intensity LEDs and tall dome with dust cover and branch guard
<b>251HTCL-BG:</b>	High Intensity LEDs and tall dome and branch guard
<b>251HTSL-BG:</b>	High Intensity LEDs and short dome and branch guard

### Specifications:

- **Dimensions:**
  - (Short Dome): 6-7/8" tall x 6-1/2" dia.
  - (Tall Dome): 8-21/32" tall x 6-1/2" dia.
- **Voltage: 12-24V DC (permanent mount)**
- **Amp Draw: 0.7 Amps @ 12V DC, 0.35 Amps @ 24V DC**
- **Lens Colors: Amber, Blue, Clear, Green, Red**
- **Low voltage warning**
- **Approvals: SAE Class 1 (Amber)**

## ENTORNO INDUSTRIAL, S.A. DE C.V.

Juan Sarabia No. 205. Col. Nueva Santa María. 02800 México, D.F.  
Tels.: (55) 5356-7206 • Fax: (55) 5356-7209  
e-mail: ventas@entorno-industrial.com • direccion@entorno-industrial.com

www.entorno-industrial.com





**200CH8L & 200CHL SERIES**



**200CFHL Series**



**200CHL Series**

**Models:**

- 200CH8L:** SAE Class I, Ultra High Intensity STAR Halo® LED Optics, Permanent Mount
- 200CFH8L:** SAE Class I, Ultra High Intensity STAR Halo® LED Optics, Permanent Mount, 3-Hole Flange Mount
- 200CHL:** SAE Class I, High Intensity STAR Halo® LED Optics, Permanent Mount
- 200CFHL:** SAE Class I, High Intensity STAR Halo® LED Optics, Permanent Mount, 3-Hole Flange Mount

**Specifications:**

- Heavy-duty spun aluminum base and universal mounting: permanent mount, 3-hole flange mount
- Durable polycarbonate lens

- Dimensions:** 7-9/16" tall x 7-3/4" dia., 4 lbs.
- Voltage:** 12V-24V DC
- Amp Draw:** 0.6 Amps @ 12V DC, 0.3 Amps @ 24V DC
- LED Colors:** Amber, Blue, Red, White
- Lens Colors:** Amber, Blue, Clear, Green, Red
- Approvals:** SAE Class I (Amber)  
(Does not apply to all flash patterns)

**200SH8L & 200SHL SERIES**



**200SHL Series**



**200SHLM Series**



**Cig Plug includes Pattern Select and On/Off Switches**

**Models:**

- 200SH8L:** SAE Class I, Ultra High Intensity STAR Halo® LED Optics, 1/2" Pipe Mount
- 200SH8LM:** SAE Class I, Ultra High Intensity STAR Halo® LED Optics, Magnetic Mount
- 200SHL:** SAE Class I, High Intensity STAR Halo® LED Optics, 1/2" Pipe Mount
- 200SHLM:** SAE Class I, High Intensity STAR Halo® LED Optics, Magnetic Mount

**Specifications:**

- Rugged die-cast aluminum base with powder coat finish and universal mounting: permanent mount, standard 1/2" pipe mount, optional magnetic mount with cigarette plug adapter
- Durable polycarbonate lens

- Dimensions:** 6-1/4" tall x 5-1/2" dia., 3 lbs.
- Voltage:** 12V-24V DC
- Amp Draw:** 0.6 Amps @ 12V DC, 0.3 Amps @ 24V DC
- LED Colors:** Amber, Blue, Red, White
- Lens Colors:** Amber, Blue, Clear, Green, Red
- Approvals:** SAE Class I (Amber)  
(Does not apply to all flash patterns)





**240HCL Series**



**Cig Plug includes Pattern Select and On/Off Switches**



**240HSFL Series**



**240HSL Series**

**240H8A Tall Lens w/Dust Cover Models:**

- 240H8AFL:** SAE Class I, California Title 13, Ultra High Intensity STAR Halo® LED Optics, 1/2" Pipe/Flange Mount
- 240H8AFL1:** SAE Class I, California Title 13, Ultra High Intensity STAR Halo® LED Optics, 1" Pipe/Flange Mount
- 240H8AL:** SAE Class I, California Title 13, Ultra High Intensity STAR Halo® LED Optics, 1/2" Pipe Mount
- 240H8AL1:** SAE Class I, California Title 13, Ultra High Intensity STAR Halo® LED Optics, 1" Pipe Mount
- 240H8ALM:** SAE Class I, California Title 13, Ultra High Intensity STAR Halo® LED Optics, Magnetic Mount

**240H8C & 240HC Tall Lens Models:**

- 240H8CFL:** SAE Class I, Ultra High Intensity STAR Halo® LED Optics, 1/2" Pipe/Flange Mount
- 240H8CFL1:** SAE Class I, Ultra High Intensity STAR Halo® LED Optics, 1" Pipe/Flange Mount
- 240H8CL:** SAE Class I, Ultra High Intensity STAR Halo® LED Optics, 1/2" Pipe Mount
- 240H8CL1:** SAE Class I, Ultra High Intensity STAR Halo® LED Optics, 1" Pipe Mount
- 240H8CLM:** SAE Class I, Ultra High Intensity STAR Halo® LED Optics, Magnetic Mount
- 240HCFL:** SAE Class I, High Intensity STAR Halo® LED Optics, 1/2" Pipe/Flange Mount
- 240HCFL1:** SAE Class I, High Intensity STAR Halo® LED Optics, 1" Pipe/Flange Mount
- 240HCL:** SAE Class I, High Intensity STAR Halo® LED Optics, 1/2" Pipe Mount
- 240HCL1:** SAE Class I, High Intensity STAR Halo® LED Optics, 1" Pipe Mount
- 240HCLM:** SAE Class I, High Intensity STAR Halo® LED Optics, Magnetic Mount

**240H8S & 240HS Short Lens Models:**

- 240H8SFL:** SAE Class I, Ultra High Intensity STAR Halo® LED Optics, 1/2" Pipe/Flange Mount
- 240H8SFL1:** SAE Class I, Ultra High Intensity STAR Halo® LED Optics, 1" Pipe/Flange Mount
- 240H8SL:** SAE Class I, Ultra High Intensity STAR Halo® LED Optics, 1/2" Pipe Mount
- 240H8SL1:** SAE Class I, Ultra High Intensity STAR Halo® LED Optics, 1" Pipe Mount
- 240H8SLM:** SAE Class I, Ultra High Intensity STAR Halo® LED Optics, Magnetic Mount
- 240HSFL:** SAE Class I, High Intensity STAR Halo® LED Optics, 1/2" Pipe/Flange Mount
- 240HSFL1:** SAE Class I, High Intensity STAR Halo® LED Optics, 1" Pipe/Flange Mount
- 240HSL:** SAE Class I, High Intensity STAR Halo® LED Optics, 1/2" Pipe Mount
- 240HSL1:** SAE Class I, High Intensity STAR Halo® LED Optics, 1" Pipe Mount
- 240HSLM:** SAE Class I, High Intensity STAR Halo® LED Optics, Magnetic Mount

**Specifications:**

- Rugged die-cast aluminum base with powder coat finish and universal mounting: permanent mount, flange mount, standard 1/2" pipe mount; available 1" pipe mount, optional magnetic mount with cigarette plug adapter
- Durable polycarbonate lens

**Dimensions:** (Short Dome): 4-1/4" tall x 5-1/2" dia., 2 lbs.  
 (Tall Dome): 6" tall x 5-1/2" dia., 3 lbs.

**Voltage:** 12V-24V DC

**Amp Draw:** 0.6 Amps @ 12V DC, 0.3 Amps @ 24V DC

**Lens Colors:** Amber, Blue, Clear, Green, Red

**Approvals:** SAE Class I (Amber)  
 (Does not apply to all flash patterns)



# STAR HALO® LED BEACONS

## 255H8TL & 255HTL SERIES



255HTCL Series



255HTSL Series



Cig Plug includes Pattern Select and On/Off Switches

### Models:

- 255H8TALV:** SAE Class I, California Title 13, Ultra High Intensity STAR Halo® LED Optics, Vacuum Magnetic Mount, Tall Lens w/Dust Cover
- 255H8TAL:** SAE Class I, California Title 13, Ultra High Intensity STAR Halo® LED Optics, Flange Mount, Tall Lens w/Dust Cover
- 255H8TCLV:** SAE Class I, Ultra High Intensity STAR Halo® LED Optics, Vacuum Magnetic Mount, Tall Lens
- 255H8TCL:** SAE Class I, Ultra High Intensity STAR Halo® LED Optics, Flange Mount, Tall Lens
- 255H8TSL:** SAE Class I, Ultra High Intensity STAR Halo® LED Optics, Flange Mount, Short Lens
- 255HTCLV:** SAE Class I, High Intensity STAR Halo® LED Optics, Vacuum Magnetic Mount, Tall Lens
- 255HTCL:** SAE Class I, High Intensity STAR Halo® LED Optics, Flange Mount, Tall Lens
- 255HTSLV:** SAE Class I, High Intensity STAR Halo® LED Optics, Vacuum Magnetic Mount, Short Lens
- 255HTSL:** SAE Class I, High Intensity STAR Halo® LED Optics, Flange Mount, Short Lens

### Specifications:

- Lightweight polycarbonate, universal flange base: 3-hole permanent mount, 1" pipe mount, optional vacuum magnetic mount with cigarette plug adapter
  - Durable polycarbonate, Twist On/Off Lens
- Dimensions:** (Short Dome): 4-3/4" tall x 6-13/32" dia., 2 lbs.  
(Tall Dome): 6-11/16" tall x 6-13/32" dia., 3 lbs.
- Voltage:** 12V-24V DC
- Amp Draw:** 0.6 Amps @ 12V DC, 0.3 Amps @ 24V DC
- Lens Colors:** Amber, Blue, Clear, Green, Red
- Approvals:** SAE Class I (Amber) (Does not apply to all flash patterns)

## 257H8TL & 257HTL SERIES



257HTCL Series



Cig Plug includes Pattern Select and On/Off Switches

### Models:

- 257H8TALV:** SAE Class I, California Title 13, Ultra High Intensity STAR Halo® LED Optics, Vacuum Magnetic Mount, Tall Lens w/Dust Cover
- 257H8TAL:** SAE Class I, California Title 13, Ultra High Intensity STAR Halo® LED Optics, Flange Mount, Tall Lens w/Dust Cover
- 257H8TCLV:** SAE Class I, Ultra High Intensity STAR Halo® LED Optics, Vacuum Magnetic Mount, Tall Lens
- 257H8TCL:** SAE Class I, Ultra High Intensity STAR Halo® LED Optics, Flange Mount, Tall Lens
- 257H8TSL:** SAE Class I, Ultra High Intensity STAR Halo® LED Optics, Flange Mount, Short Lens
- 257HTCLV:** SAE Class I, High Intensity STAR Halo® LED Optics, Vacuum Magnetic Mount, Tall Lens
- 257HTCL:** SAE Class I, High Intensity STAR Halo® LED Optics, Flange Mount, Tall Lens
- 257HTSLV:** SAE Class I, High Intensity STAR Halo® LED Optics, Vacuum Magnetic Mount, Short Lens
- 257HTSL:** SAE Class I, High Intensity STAR Halo® LED Optics, Flange Mount, Short Lens

### Specifications:

- Die-cast metal, universal flange mount: 3-hole permanent mount, 1" pipe mount, optional vacuum magnetic mount with cigarette plug
  - Durable polycarbonate, Twist On/Off Lens
- Dimensions:** (Short Dome): 4-3/4" tall x 6-13/32" dia., 2 lbs.  
(Tall Dome): 6-11/16" tall x 6-13/32" dia., 3 lbs.
- Voltage:** 12V-24V DC
- Amp Draw:** 0.6 Amps @ 12V DC, 0.3 Amps @ 24V DC
- Lens Colors:** Amber, Blue, Clear, Green, Red
- Approvals:** SAE Class I (Amber)  
(Does not apply to all flash patterns)



257HTSL Series

## ENTORNO INDUSTRIAL, S.A. DE C.V.

Juan Sarabia No. 205. Col. Nueva Santa María. 02800 México, D.F.  
Tels.: (55) 5356-7206 • Fax: (55) 5356-7209  
e-mail: ventas@entorno-industrial.com • direccion@entorno-industrial.com

www.entorno-industrial.com







**200ZL Series**

\*Magnetic mount includes metal disk with hook and loop fasteners for easy dash mounting.

PARTS	
Lens .....	330
Gasket .....	381
Clamp Ring .....	365-Z
Magnet .....	177
Cig Plug with Lighted on/off Switch .....	176-SW
Eye Shield .....	386



**201ZL Series**

\*Magnetic mount includes metal disk with hook and loop fasteners for easy dash mounting.

PARTS	
Lens .....	330-1
O-ring Gasket .....	381-1
Magnet .....	177
Cig Plug with Lighted on/off Switch .....	176-SW
Eye Shield .....	386

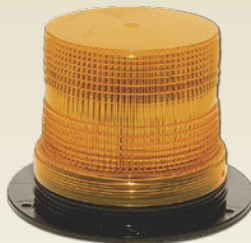

**203MVL Series**

PARTS	Part #
Lens .....	320



**204MVL Series**

PARTS	Part #
Lens .....	234

These 360° LED beacons are compact and powerful. The 200ZL offers a polycarbonate lens clamped to a rugged die-cast aluminum base with a fully gasketed aluminum retaining ring to enhance water resistance.

The 201ZL offers a polycarbonate, quick-snap lens and base assembly for easy field repairs. The polycarbonate lens is sealed to the base with a water resistant enhanced O-ring.

The 203MVL offers a twist on/off lens for quick field maintenance and a durable polycarbonate plastic base with flange.

The 204MV is a space saving solution. It offers a twist on/off lens for quick field maintenance and a durable plastic, flange mount base. Twenty-nine customer selectable flash patterns with an extremely low current draw gives these beacons many flexible options. The fully encapsulated circuitry and long life LEDs (rated for up to 10,000 hours) ensures trouble free operation. Ships complete with mounting hardware and instructions.

### Models:

**200ZL Series:** 200ZL: Permanent Mount, 200ZLM\*: Magnetic Mount  
200ZL-48: Permanent Mount  
3-3/4"H x 4-1/8"Dia., 2 lbs.

**201ZL Series:** 201ZL: Permanent Mount, 201ZLM\*: Magnetic Mount  
201ZL-48: Permanent Mount  
3-3/4"H x 4-1/4"Dia., 1.5 lbs.

**203MVL Series:** 203MVL: Permanent Mount, 203MVL M: Magnetic Mount  
203MVL-48: Permanent Mount  
3-1/2"H x 5-1/16"Dia., 1 lb.

**204MVL Series:** 204MVL: Flange Mount Only  
204MVL-48: Permanent Mount  
5"H x 4-7/8"Dia., 1 lb.

### Specifications:

**Voltage:** 200ZL, 201ZL, 203MVL, 204MVL: 10V-16V DC  
200ZL-48, 201ZL-48, 203MVL-48, 204MVL-48: 10V-48V DC

**Amp Draw:** 200ZL, 201ZL, 203MVL, 204MVL: 0.35 Amps @ 10V-16V DC  
200ZL-48, 201ZL-48, 203MVL-48, 204MVL-48:  
0.13 Amps @ 10V-48V DC

**LEDs:** Two Star Generation-4 LEDs

**Color:** Amber lens with Amber LED

**Mounting\*:** Permanent Mount  
Flange Mount  
1/2" Pipe Mount  
Magnetic Mount  
\* does not apply to all lights

**Approvals:** SAE J845 Class III (Amber)



# STROBE BEACONS

## 200A & 200B SERIES - HIGH PROFILE, HEAVY DUTY



The 200A and 200B series are built with heavy-duty spun aluminum bases. The 200A has an open bottom while the 200B has an enclosed bottom. Each has a smooth outer dome for easy cleaning which also protects the inner fresnel lens. Field-selectable flash patterns via an internal jumper for quad flash, double flash, or single flash, RFI protection, and patented LED diagnostic indicator are standard. Ships complete with mounting hardware and instructions.

### Models:

<b>200A Series:</b>	200A: Single Flash, Double Flash, or Quad Flash, 200ADH: High Power, Double Flash; 200AQH: High Power, Quad Flash 7-3/4"H x 9"Dia., 4 lbs.
<b>200B Series:</b>	200B: Single Flash, Double Flash, or Quad Flash 200BDH: High Power, Double Flash; 200BQH: High Power, Quad Flash 6-7/8"H x 8-1/4"Dia., 4 lbs.

### Specifications:

<b>Voltage:</b>	12V - 24V DC
<b>Amp Draw:</b>	2 Amps Max (High Power: 3.2 Amps)
<b>Joules:</b>	<b>Single Flash:</b> 11.35 joules @ 100fpm <b>Double Flash:</b> 18.7 joules @ 65dfpm <b>Quad Flash:</b> 17.6 joules @ 75qfpm <b>High Power Double or Quad Flash:</b> 23 joules
<b>Lens color:</b>	Amber, Blue, Clear, Green, Red, Magenta
<b>Mounting:</b>	<b>200A Series:</b> Permanent mount <b>200B Series:</b> Permanent or 3/4" pipe mount
<b>Approvals:</b>	<b>200B (Single Flash):</b> CSA <b>200A, 200B (Single Flash):</b> SAE J1318 Class 2 Amber, Blue, Clear, Red <b>200A, 200B (Double Flash):</b> SAE J1318 Class 1 Amber, Blue, Clear Class 2: Red <b>200A, 200B (Quad Flash):</b> SAE J1318 Class 1 Amber, Blue, Clear, Red California Title 13 - Amber

Selectable Hi/Lo intensity is a standard feature on standard power Double and Quad Flash models. An optional photocell is available for High Power models that automatically switches to lower intensity in low light conditions.

### PARTS

Outer Dome.....	134-L
Lens.....	300
Strobe Tube.....	129 or 129-DH (High Power)
Circuit (Standard Power).....	181-SDQ-12
Circuit (Double Flash, High Power).....	181-DH-12
Circuit (Quad Flash, High Power).....	181-QH-12
Channel Gasket.....	111A
Clamp Ring (200B).....	4022
Plastic Base Insert (200A).....	101-AP

## 200C & 200E SERIES - MOST BASIC



The 200C and 200E series are basic strobe lights that are economically priced. They are built tough with anodized spun aluminum bases for increased durability and weather resistance. Ideal for medium to heavy duty applications. Field-selectable flash patterns via an internal jumper for quad flash, double flash, or single flash, RFI protection, and patented LED diagnostic indicator are standard. Ships complete with mounting hardware and instructions.

### Models:

<b>200C Series:</b>	200C, 200CF Single Flash, Double Flash, Quad Flash, 200CDH: High Power, Double Flash, 200CQH: High Power, Quad Flash 7-9/16"H x 7-3/4"Dia., 4 lbs.
<b>200E Series:</b>	200E: Single Flash 7-9/16"H x 7-3/4"Dia., 4 lbs.

### Specifications:

<b>Voltage:</b>	<b>200C Series:</b> 12V - 24V DC <b>200E:</b> 110V - 120V DC
<b>Amp Draw:</b>	2 Amps Max (High Power: 3.2 Amps)
<b>Joules:</b>	<b>Single Flash:</b> 11.35 joules @ 100fpm <b>Double Flash:</b> 18.7 joules @ 65dfpm <b>Quad Flash:</b> 17.6 joules @ 75qfpm <b>High Power Double or Quad Flash:</b> 23 joules
<b>Lens color:</b>	Amber, Blue, Clear, Green, Red, Magenta
<b>Mounting:</b>	<b>200C Series:</b> Permanent or Flange Mount <b>200E:</b> Permanent or 3/4" Pipe Mount
<b>Approvals:</b>	<b>200C (Single Flash):</b> SAE J1318 Class 2 Amber, Blue, Clear, Red <b>200C (Double Flash):</b> SAE J1318 Class 1 Amber, Blue, Clear SAE J1318 Class 2 Red <b>200E:</b> ULC Approved <b>200CQH:</b> SAE J1318 Class 1 Amber, Blue, Clear, Red California Title 13 Amber

Selectable Hi/Lo intensity is a standard feature on standard power Double and Quad Flash models. An optional photocell is available for High Power models that automatically switches to lower intensity in low light conditions.

### PARTS

Lens.....	300
Strobe Tube.....	129 or 129-DH (High Power)
Circuit (Standard Power).....	181-SDQ-12
Circuit (Double Flash, High Power).....	181-DH-12
Circuit (Quad Flash, High Power).....	181-QH-12
Circuit (200E).....	181-110
Channel Gasket.....	111C

## ENTORNO INDUSTRIAL, S.A. DE C.V.

Juan Sarabia No. 205. Col. Nueva Santa María. 02800 México, D.F.  
Tels.: (55) 5356-7206 • Fax: (55) 5356-7209  
e-mail: ventas@entorno-industrial.com • direccion@entorno-industrial.com

www.entorno-industrial.com





**250 SERIES - HIGH POWER**



**250C Series**

**250S Series**

Selectable Hi/Lo intensity is a standard feature on Double and Quad Flash models. An optional photocell is available that automatically switches to lower intensity.

**PARTS**

Outer Dust Cover (250A).....	296
Lens (250C & 250A).....	295
Lens (250S).....	297
Strobe Tube.....	129-DH
Timing Head (Single Flash).....	180
Power Supply (High Power Single Flash).....	(2)181-12
Circuit (High Power Double Flash).....	181-DH-12
Circuit (High Power Quad Flash).....	181-QH-12
Circuit (Standard Power).....	181-SDQ-12
Base Plate, Flange.....	331

The 250 series is built for High Power and High Visibility. An anodized spun aluminum case and rugged die-cast base plate makes this light durable for any heavy duty application. A fully gasketed lens and base protects against the elements. Standard power models are also available (250A, 250C, 250S with field-selectable flash patterns via an internal jumper for quad flash, double flash, or single flash, RFI protection, and patented LED diagnostic indicator are standard.) Ships complete with mounting hardware and instructions.

**Models:**

**250C Series:** 250AH: Single Flash w/Dust Cover; 250ADH: Double Flash w/Dust Cover; 250AQH: Quad Flash w/Dust Cover; 250CH: Single Flash; 250CDH: Double Flash; 250CQH: Quad Flash; 8”H x 5-1/2”Dia., 5 lbs.

**250S Series:** 250SH: Single Flash; 250SDH: Double Flash; 250SQH: Quad Flash 6-1/8”H x 5-1/2”Dia., 5 lbs

**High Power Specifications:**

<b>Voltage:</b>	<b>Single Flash:</b>	12V DC
	<b>Double or Quad Flash:</b>	12V - 24V DC
<b>Amp Draw:</b>	<b>Single Flash:</b>	3.6 Amps
	<b>Double or Quad Flash:</b>	3.2 Amps
<b>Joules:</b>	<b>Single Flash:</b>	20 joules
	<b>Double or Quad Flash:</b>	23 joules
<b>Lens color:</b>	Amber, Blue, Clear, Green, Red, Magenta	
<b>Mounting:</b>	Flange Mount (2 holes on 6-7/8” centers)	
<b>Approvals:</b>	<b>250ADH, 250ADHP, 250CDH, 250CDHP:</b>	SAE J1318 Class 1: Amber TXDOT Specifications: SDHPT - 055057 - 0189 California Administrative Code, AAMVA - 12V DC
	<b>250ADH, 250CDH, 250SDH:</b>	
	<b>250CQH:</b>	SAE Class 1: Amber, Red California Title 13: Amber

**255HTC - HIGH PROFILE - LED DIAGNOSTICS**



**255HTC Series**

**255HTCM Series**

The 255HTC offers a patented LED diagnostic indicator, a photocell for automatic “night” mode switching, and field-selectable flash patterns via an internal jumper for quad flash, double flash, or single flash. Lens easily twists on/off the durable and lightweight plastic, universal mount, flanged base. The modular circuit is completely encapsulated for increased shock and weather resistance and is also protected with a low voltage shutdown feature. RFI protection is standard. Ships complete with mounting hardware and instructions.

**Models:**

**255HTC Series:** 255HTC: Flange/Pipe Mount  
255HTCM: Magnetic Mount  
6-11/16”H x 6-13/32”Dia., 3 lbs.

**Specifications:**

<b>Voltage:</b>	12V-24V DC
<b>Amp Draw:</b>	2 Amps @ 12V DC 1 Amps @ 24V DC
<b>Joules:</b>	19.5 joules (Quad Flash mode)
<b>Lens color:</b>	Amber, Blue, Clear, Green, Red, Magenta
<b>Mounting:</b>	Universal Flange Mount 1” Pipe Mount Magnetic Mount
<b>Approvals:</b>	SAE J1318 in Quad Flash mode Class 1: Amber, Blue, Clear Class 2: Red

**PARTS**

Lens.....	295TC
Strobe Tube.....	129
Circuit.....	181-HT-DQ
Cig Plug with Lighted on/off Switch.....	176-SW
Magnet Mount Kit.....	177-3
O-Ring Gasket.....	30047-41



# STROBE BEACONS

## 255TC & 255TS - STARS WITH A TWIST



255TC Series

255TS Series

The 255TC & 255TS series offer field selectable flash patterns of quad flash, double flash, or single flash via an internal jumper. Lens easily twists on/off the durable and lightweight plastic, universal mount, flanged base. The modular circuit is completely encapsulated for increased shock and weather resistance, and is also protected with a low voltage shutdown feature. Ships complete with mounting hardware and instructions.

### Models:

**255TC Series:** 255TC: Flange Mount;  
255TCM: Magnetic Mount;  
255TCV: Vacuum Magnetic Mount;  
6-11/16"H x 6-13/32"Dia., 3 lbs.

**255TS Series:** 255TS: Flange Mount;  
255TSM: Magnetic Mount  
255TSV: Vacuum Magnetic Mount  
4-3/4"H x 6-13/32"Dia., 2 lbs.

### Specifications:

**Voltage:** 12V-48V DC  
**Amp Draw:** 1.2 Amps @ 12V DC  
0.6 Amps @ 24V DC  
0.3 Amps @ 36V DC  
0.175 Amps @ 48V DC

**Joules:** **Double Flash:** 7 joules  
**Quad Flash:** 10 joules

**Lens color:** Amber, Blue, Clear, Green, Red, Magenta  
**Mounting:** Universal Flange Mount  
1" Pipe Mount  
Magnetic Mount  
Vacuum Magnetic Mount

**Approvals:** SAE J1318 Class 2: Amber, Blue, Clear, Red (Quad Flash mode)

### PARTS

Lens (255TC Series).....	295TC
Lens (255TS Series).....	297TS
Strobe Tube.....	129
Circuit.....	181-T-DQ
Cig Plug with Lighted on/off Switch.....	176-SW
Magnet Mount Kit.....	177-3
Vacuum Magnet Mount.....	920-16V
O-Ring Gasket.....	30047-41

## 200S SERIES - MEDIUM PROFILE



200S Series

The 200S series are our most popular medium profile strobe lights. The rugged die-cast base is fully gasketed and the modular circuit is completely encapsulated for increased shock and weather resistance. Field-selectable flash patterns via an internal jumper for quad flash, double flash, or single flash, RFI protection, and patented LED diagnostic indicator are standard. Ships complete with mounting hardware and instructions.

### Models:

**200S Series:** 200S, 200SM: Single Flash, Double Flash, Quad Flash  
6-1/4"H x 5-1/2"Dia., 3 lbs.

### Specifications:

**Voltage:** 12V - 24V DC  
**Amp Draw:** 2 Amps @ 12V DC  
**Joules:** **Single Flash:** 11.35 joules @ 100fpm  
**Double Flash:** 18.7 joules @ 65dfpm  
**Quad Flash:** 17.6 joules @ 75qfpm

**Lens color:** Amber, Blue, Clear, Green, Red, Magenta  
**Mounting:** Permanent Mount  
1/2" Pipe Mount  
Magnetic Mount

**Approvals:** **200S**  
**(Single Flash):** SAE J1318 Class 2  
Amber, Blue, Clear, Red

**200S**  
**(Double Flash & Quad Flash):**  
SAE J1318 Class 1  
Amber, Blue, Clear  
Class 2: Red

Selectable Hi/Lo intensity is a standard feature on Double and Quad Flash models.

### PARTS

Lens.....	300-S
Strobe Tube.....	129
Circuit.....	181-SDQ4-12
Cig Plug with Lighted on/off Switch.....	176-SW
Lens Gasket.....	369
Base.....	4100LF
Clamp Ring.....	365

## ENTORNO INDUSTRIAL, S.A. DE C.V.

Juan Sarabia No. 205. Col. Nueva Santa María. 02800 México, D.F.  
Tels.: (55) 5356-7206 • Fax: (55) 5356-7209  
e-mail: ventas@entorno-industrial.com • direccion@entorno-industrial.com

www.entorno-industrial.com





**240 SERIES - MEDIUM PROFILE**



**240C Series**

**240S Series**

Selectable Hi/Lo intensity is a standard feature on Double and Quad Flash models.

PARTS	
Lens (240C)	295
Lens (240S)	297
Strobe Tube	129
Circuit	181-SDQ4-12
Magnet	177
Cig Plug with Lighted on/off Switch	176-SW

The 240 Series is our most popular and most versatile strobe light. The circuit is completely encapsulated for increased shock and weather resistance. The rugged die-cast aluminum base is protected with a powder coat finish. Field-selectable flash patterns via an internal jumper for quad flash, double flash, or single flash, RFI protection, and patented LED diagnostic indicator are standard. Ships complete with mounting hardware and instructions.

**Models:**

**240C Series:** 240C, 240CF, 240CM: Single Flash, Double Flash, Quad Flash  
6"H x 5-1/2"Dia., 3 lbs.

**240S Series:** 240S, 240SF, 240SM: Single Flash, Double Flash, Quad Flash  
4-1/4"H x 5-1/2"Dia., 2 lbs.

**Specifications:**

<b>Voltage:</b>	12V - 24V DC
<b>Amp Draw:</b>	2.0 Amps
<b>Joules:</b>	<b>Single Flash:</b> 11.35 joules @ 100fpm <b>Double Flash:</b> 18.7 joules @ 65dfpm <b>Quad Flash:</b> 17.6 joules @ 75qfpm
<b>Lens color:</b>	Amber, Blue, Clear, Green, Red, Magenta
<b>Mounting:</b>	Permanent Mount, 1/2" Pipe Mount, Flange Mount Magnetic Mount
<b>Approvals:</b>	<b>240S Single Flash:</b> SAE J1318 Class 2 Amber, Blue, Clear, Red <b>Double Flash:</b> SAE J1318 Class 2 Amber, Blue, Clear, Red <b>Quad Flash:</b> SAE J1318 Class 1 Blue SAE J1318 Class 2 Amber, Clear, Red <b>240C Single Flash:</b> SAE J1318 Class 2 Amber, Blue, Clear, Red <b>Double Flash &amp; Quad Flash:</b> SAE J1318 Class 1 Amber, Blue, Clear SAE J1318 Class 2 Red <b>240A Double Flash &amp; Quad Flash:</b> SAE J1318 Class 1 Amber, Clear

**242 SERIES - MEDIUM PROFILE - LED DIAGNOSTICS**



**242CL Series**

**242SL Series**

PARTS	
Lens (242C)	295
Lens (242S)	297
Strobe Tube	129
Circuit	181-HT-DQ
Cig Plug with Lighted on/off Switch	176-SW
Magnet	177

The 242 Series offers a patented LED diagnostic indicator, a photocell for automatic "night" mode switching and field selectable flash patterns of quad flash, double flash, or single flash via an internal jumper. The modular circuit is completely encapsulated for increased shock and weather resistance. The rugged die-cast aluminum base is protected with a powder coat finish. RFI protection is standard. Ships complete with mounting hardware and instructions.

**Models:**

**242CL Series:** 242CL: Permanent Mount; 242CFL: Flange Mount; 242CLM: Magnetic Mount  
6"H x 5-1/2"Dia., 3 lbs.

**242SL Series:** 242SL: Permanent Mount; 242SFL: Flange Mount; 242SLM: Magnetic Mount  
4-1/4"H x 5-1/2"Dia., 2 lbs.

**Specifications:**

<b>Voltage:</b>	12V-24V DC
<b>Amp Draw:</b>	2 Amps @ 12V DC 1 Amps @ 24V DC
<b>Joules:</b>	19.5 joules (Quad Flash)
<b>Lens color:</b>	Amber, Blue, Clear, Green, Red, Magenta
<b>Mounting:</b>	Permanent Mount Flange Mount 1/2" Pipe Mount Magnetic Mount
<b>Approvals:</b>	<b>242S Quad Flash:</b> SAE J1318 Class 1 Clear SAE J1318 Class 2 Amber, Blue, Red <b>242C Quad Flash:</b> SAE J1318 Class 1 Amber, Blue, Clear SAE J1318 Class 2 Red

**ENTORNO INDUSTRIAL, S.A. DE C.V.**

Juan Sarabia No. 205. Col. Nueva Santa Maria. 02800 México, D.F.  
Tels.: (55) 5356-7206 • Fax: (55) 5356-7209  
e-mail: ventas@entorno-industrial.com • direccion@entorno-industrial.com

www.entorno-industrial.com





# STROBE BEACONS

## 241S SERIES - VERY LOW PROFILE



**241S Series**

Selectable Hi/Lo intensity is a standard feature on Double and Quad Flash models.

### PARTS

Lens .....	298
Strobe Tube .....	129-R
Circuit .....	181-SDQ4-12
Magnet .....	177
Cig Plug with Lighted on/off Switch .....	176-SW

At only 3" tall, the 241S Series strobes will fit where other strobes won't. The modular circuit is completely encapsulated for increased shock and weather resistance. The rugged die-cast aluminum base is protected with a powder coat finish. Field-selectable flash patterns via an internal jumper for quad flash, double flash, or single flash, RFI protection, and patented LED diagnostic indicator are standard. Ships complete with mounting hardware and instructions.

### Models:

**241 Series:** 241S 241SF, 241SM: Single Flash, Double Flash, Quad Flash  
3-1/4"H x 5-1/2"Dia., 2 lbs.

### Specifications:

**Voltage:** 12V - 24V DC

**Amp Draw:** 2.0 Amps

<b>Joules:</b>	<b>Single Flash:</b>	11.35 joules @ 100fpm
	<b>Double Flash:</b>	18.7 joules @ 65dfpm
	<b>Quad Flash:</b>	17.6 joules @ 75qfpm

**Lens color:** Amber, Blue, Clear, Green, Red, Magenta

**Mounting:** Permanent Mount  
1/2" Pipe Mount  
Flange Mount  
Magnetic Mount

## 211R SERIES - VERY LOW PROFILE - RUBBER BASE



**211R Series & 211RM Series**

At only 4" tall, the 211R Series strobe lights offer a molded rubber base to absorb shock and vibration and to prevent corrosion. The 211RM Series offers our NEW NeoForce™ Magnet Technology. The magnet is concealed inside the molded rubber base and will not scratch the roof of your vehicle! Ships complete with mounting hardware and instructions.

### Models:

**211R Series:** 211R: Single Flash; 211RQ: Quad Flash;  
211RM: Single Flash; 211RMQ: Quad Flash  
4" H x 5-3/4" Dia., 3 lbs.

### Specifications:

<b>Voltage:</b>	<b>Single Flash:</b>	12V DC (Available 24V DC)
	<b>Quad Flash:</b>	12V DC only

**Amp Draw:** 0.5 Amps @ 12V DC  
0.3 Amps @ 24V DC

<b>Joules:</b>	<b>Single Flash:</b>	3 joules
	<b>Quad Flash:</b>	3.75 joules

**Lens color:** Amber, Blue, Clear, Green, Red, Magenta

**Mounting:** Permanent Mount on 2 studs on 4-1/8" centers  
Magnetic Mount

### PARTS

Lens .....	298
Strobe Tube .....	129-Z
Circuit (Single Flash) .....	181-Z11-12
Circuit (Quad Flash) .....	181-ZQ11-12
Cig Plug with Lighted on/off Switch .....	176-SW

## ENTORNO INDUSTRIAL, S.A. DE C.V.

Juan Sarabia No. 205. Col. Nueva Santa María. 02800 México, D.F.  
Tels.: (55) 5356-7206 • Fax: (55) 5356-7209  
e-mail: ventas@entorno-industrial.com • direccion@entorno-industrial.com

www.entorno-industrial.com





# STROBE BEACONS

## 200Z SERIES - COMPACT LOW PROFILE



200Z Series

The 200Z Series is a compact and powerful, low profile strobe that is ideal for construction, forklift, or many other applications. The polycarbonate lens is clamped to the rugged die-cast aluminum base with a fully gasketed aluminum retaining ring to enhance water resistance. Ships complete with mounting hardware and instructions.

### Models:

**200Z Series:** 200Z: Single Flash; 200ZQ: Quad Flash;  
200ZM\*: Single Flash; 200ZMQ\*: Quad Flash  
3-3/4"H x 4-1/8"Dia., 2 lbs.

### Specifications:

**Voltage:** **Single Flash:** 12V DC  
(available 24V, 36V, 48V DC, or  
110V-120V, 220V AC)  
**Quad Flash:** 12V DC Only

**Amp Draw:** 0.5 Amps @ 12V DC  
0.3 Amps @ 24V DC

**Joules:** **Single Flash:** 3 joules  
**Quad Flash:** 3.75 joules

**Lens color:** Amber, Blue, Clear, Green, Red, Magenta

**Mounting:** Permanent Mount  
1/2" Pipe Mount  
Magnetic Mount

\*Magnetic mount includes metal disk with hook and loop fasteners for easy dash mounting.

### PARTS

Lens .....	330
Strobe Tube .....	129-Z
Circuit (Single Flash) .....	181-Z-12
Circuit (Quad Flash) .....	181-ZQ-12
Gasket .....	381
Clamp Ring .....	365-Z
Magnet .....	177
Cig Plug with Lighted on/off Switch .....	176-SW
Eye Shield .....	386

## 201Z SERIES - COMPACT LOW PROFILE



201Z Series

The 201Z Series is a small, dynamic, low profile strobe with a quick-snap lens and a high impact resistant plastic base assembly for easy field repairs. The polycarbonate lens is sealed to the base with a water resistant enhanced O-ring. Ships complete with mounting hardware and instructions.

### Models:

**201Z Series:** 201Z: Single Flash; 201ZQ: Quad Flash;  
201ZM\*: Single Flash; 201ZMQ\*: Quad Flash  
3-3/4"H x 4-1/4"Dia., 1.5 lbs.

### Specifications:

**Voltage:** **Single Flash:** 12V DC  
(available 24V, 36V, 48V DC, or  
110V-120V, 220V AC)  
**Quad Flash:** 12V DC Only

**Amp Draw:** 0.5 Amps @ 12V DC  
0.3 Amps @ 24V DC

**Joules:** **Single Flash:** 3 joules  
**Quad Flash:** 3.75 joules

**Lens color:** Amber, Blue, Clear, Green, Red, Magenta

**Mounting:** Permanent Mount  
1/2" Pipe Mount  
Magnetic Mount

\*Magnetic mount includes metal disk with hook and loop fasteners for easy dash mounting.

### PARTS

Lens .....	330_1
Strobe Tube .....	129-Z
Circuit (Single Flash) .....	181-Z-12
Circuit (Quad Flash) .....	181-ZQ-12
O-ring Gasket .....	381-1
Magnet .....	177
Cig Plug with Lighted on/off Switch .....	176-SW
Eye Shield .....	386

## ENTORNO INDUSTRIAL, S.A. DE C.V.

Juan Sarabia No. 205. Col. Nueva Santa María. 02800 México, D.F.  
Tels.: (55) 5356-7206 • Fax: (55) 5356-7209  
e-mail: ventas@entorno-industrial.com • direccion@entorno-industrial.com

www.entorno-industrial.com



# STROBE BEACONS

## 203MV SERIES - MULTIVOLTAGE COMPACT

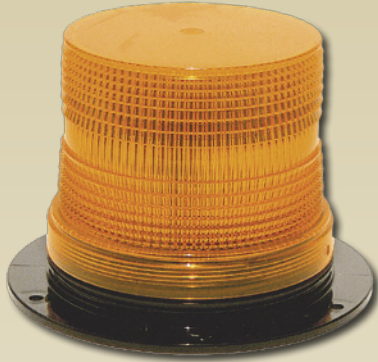

203MV Series

### LOW PROFILE

The 203MV Series is a compact, low profile strobe that is ideal for many applications. The twist on/off lens and base with flange are molded with a durable polycarbonate plastic. Ships complete with mounting hardware and instructions.

### Models:

**203MV Series:** 12V-72V DC  
3-1/2"H x 5-1/16"Dia., 1 lb.

### Specifications:

**Voltage:** 12V - 72V DC  
**Amp Draw:** 0.5 Amps  
**Joules:** 1.5 joules  
**Lens color:** Amber, Blue, Clear, Green, Red, Magenta  
**Mounting:** Flange Mount (5-1/16" diameter circle with 3 holes)

PARTS	Part #
Lens .....	320
Strobe Tube .....	129-Z
12-72V DC Circuit.....	181TMV

## 204MV SERIES - MULTIVOLTAGE COMPACT



204MV Series

### LOW PROFILE

The 204MV is a space saving solution. Fits almost anywhere! It is ideal for a wide variety of applications. The twist on/off lens and base with flange are molded with a durable polycarbonate plastic. Ships complete with mounting hardware and instructions.

### Specifications:

**Voltage:** 12V -110V DC  
**Amp Draw:** 0.5 Amps  
**Joules:** 1.75 joules  
**Lens color:** Amber, Blue, Clear, Green, Red, Magenta  
**Mounting:** Flange Mount, 1/2" Pipe Mount  
5"H x 4-7/8"Dia.  
1 lb.

PARTS	Part #
Lens .....	234
Strobe Tube .....	129-L

## ENTORNO INDUSTRIAL, S.A. DE C.V.

Juan Sarabia No. 205. Col. Nueva Santa María. 02800 México, D.F.  
Tels.: (55) 5356-7206 • Fax: (55) 5356-7209  
e-mail: ventas@entorno-industrial.com • direccion@entorno-industrial.com

www.entorno-industrial.com



# STROBE BEACONS

## 200J & 200U SERIES - SPECIAL APPLICATION



200J Series

The 200J and 200U Series strobes were designed for special application needs. The 200U is designed for indoor use with a patented AC circuit. Ships complete with mounting hardware and instructions.

**Models:**

**200J Series:** 200J: Single Flash; 200JQ: Quad Flash, 6-1/16" H x 6-1/16" Dia.  
200J-1: Single Flash; 200JQ-1: Quad Flash, 6-7/8" H x 6-1/16" Dia.  
All 2 lbs.

**200U Series:** 200U: Single Flash, 6-1/16" H x 6-1/16" Dia.  
200U-1: Single Flash, 6-7/8" H x 6-1/16" Dia.  
All 2 lbs.

**Specifications:**

**Voltage:** 200J Series: **Single Flash:** 12V DC  
(available 24V, 36V, 48V, or 72V DC)  
**Quad Flash:** 12V - 24V DC  
200U Series: **Single Flash:** 110V-120V DC

**Amp Draw:** 2 Amps

**Joules:** 3 joules

**Lens color:** Amber, Blue, Clear, Green, Red, Magenta

**Mounting:** Permanent Mount  
1/2" Pipe Mount  
Flange Mount

PARTS	Part #
Lens .....	333
Outer Dome .....	325-L
Strobe Tube (200J).....	129-Z
Strobe Tube (200U).....	129-U
Single Flash Circuit (200J).....	181-Z-12
Quad Flash Circuit (200J).....	181-ZQ-12
Single Flash Circuit (200U).....	181-U-110

## 735PS SERIES - PORTABLE



735PS

The 735PS is a convenient portable strobe. It is constructed with a high impact, safety orange, plastic base. A 360 degree lens allows for visibility in all directions. Economical battery operation (approx. 40 hours). These lights are not Coast Guard approved.

**Specifications:**

**Voltage:** Two 6 Volt spring terminal batteries (not included)

**Amp Draw:** 0.5 Amps

**Joules:** 3 joules

**Lens color:** Amber, Blue, Clear, Green, Red, Magenta

**Mounting:** Portable, Magnetic Mount Available  
11-3/4"H x 7-1/4"W x 3-1/2"D  
3 lb.

PARTS	Part #
Lens .....	300
Strobe Tube .....	129-Z
Circuit .....	181-Z-12
Battery .....	8100
Handle .....	202-104-1

## 845S SERIES - UNI-DIRECTIONAL



845S

The 845S Series are self-contained, uni-directional strobes. They offer a fully gasketed, rugged anodized aluminum case and the circuit is completely encapsulated for increased shock and weather resistance. RFI protection is available for quad flash. Ships complete with mounting hardware and instructions.

**Models:**

**845S Series:** 845S: Single Flash; 845SQ: Quad Flash  
3-5/16" H x 8-1/4" Dia., 3 lb.

**Specifications:**

**Voltage:** **Single Flash:** 12V DC  
(available 24V, 36V, 48V, 72V DC)  
**Quad Flash:** 12V - 24V DC

**Amp Draw:** 2 Amps

**Joules:** **Single Flash:** 8.3 joules  
**Quad Flash:** 17.3 joules

**Lens color:** Amber or Red

**Mounting:** Flange Mount

**Approvals:** CFR 49, Part 221 (Red)

PARTS	Part #
Lens .....	8888
Strobe Tube .....	129-R
Single Flash Circuit .....	181-S-12
Quad Flash Circuit .....	181-Q4-12

### ENTORNO INDUSTRIAL, S.A. DE C.V.

Juan Sarabia No. 205. Col. Nueva Santa María. 02800 México, D.F.  
Tels.: (55) 5356-7206 • Fax: (55) 5356-7209  
e-mail: ventas@entorno-industrial.com • direccion@entorno-industrial.com

www.entorno-industrial.com





# REVOLVING BEACONS

## 20RH/20RI/450A/450B/455BH SERIES



The 450A and 450B series are built with heavy-duty spun aluminum bases, while the 20RH and 20RI series are manufactured with rugged die-cast aluminum bases. The 450A has an open bottom while the 20RH, 20RI, and 450B have enclosed bottoms. The 455BH series are built with a durable polycarbonate plastic base. Patented shock mounted rotators with two sealed roller bearings provide quiet, smooth and maintenance free operation. Lock-and-stay bulbs are field replaceable. Durable polycarbonate plastic outer domes keep our lights corrosion, weather, and impact resistant. Ships complete with mounting hardware and instructions.

### Models:

<b>20RH/20RI Series:</b>	20RH/20RHM: Halogen; 20RI/20RIM: Incandescent 7" H x 6" Dia., 2 lbs.
<b>450A Series:</b>	450A: Incandescent; 450AH: Halogen 7-5/8" H x 8-7/8" Dia., 3 lbs.
<b>450B Series:</b>	450B: Incandescent; 450BH: Halogen 8-7/8" H x 8-1/4" Dia., 3 lbs.
<b>455BH Series:</b>	455BH: 80fpm(+/-10); 455BHf: 160fpm(+/-10) 7" H x 8" Dia., 3 lbs.

### Specifications:

<b>Voltage:</b>	12V DC
<b>Amp Draw:</b>	Incandescent: 2.7 Amps (35 watts) Halogen: 4.0 Amps (50 watts)
<b>Flash Rate:</b>	Standard: 80fpm(+/-10) High-Speed: 160fpm(+/-10) Available: 120fpm(+/-10)
<b>Lens Color:</b>	Amber, Blue, Clear, Red
<b>Filter Color:</b>	Amber, Blue, Green, Red
<b>Mounting:</b>	450A/455B: Permanent mount 450B: Permanent mount, 3/4" pipe mount 20RH/20RI: Permanent mount, 1/2" pipe mount Magnetic Mount available
<b>Approvals:</b>	450AH: SAE J845 Class1: Amber, Blue, Clear, Red 20RH: SAE J845 Class1: Amber, Blue, Clear, Red

PARTS 20RI, 20RH	PART#
Bulb 12V (Halogen)	2073-795X
12V (Incandescent)	2073-1195
24V (Incandescent)	1638
36V (Incandescent)	1062
48V (Incandescent)	10498*
Lens	325-L
Clamp Ring	4123
Base	4100
Rotator	920-0
Fast Rotator	920-0F

\*Available only from STAR

PARTS 450 Series	PART#
Bulb 12V (Halogen)	2073-795X
12V (Incandescent)	2073-1195
Lens	134-L

PARTS 455BH Series	PART#
Bulb 12V (Halogen)	2073-795
12V (Incandescent)	2073-1195
Rotator filter	920-100
Lens	134-L

## 400 SERIES



**STAR'S Revolving Sealed Beam Lights** feature heavy duty motors and shaft assemblies for dependable durability. Our top-of-the-line sealed gear assembly eliminates the need for lubrication, thus reducing required maintenance. Choose from two or four, 35 watt/33,000cp, sealed beams to generate eye-catching light that commands attention in any application. Design accommodates quick in-field repairs when those rare occasions arise. Heavy duty polycarbonate plastic outer domes keep our lights corrosion, weather, and impact resistant. Rugged construction with an anodized spun aluminum housings provide long trouble-free life. Ships complete with mounting hardware and instructions.

### Models:

<b>400 Series:</b>	400A: 2 Sealed Beam, 8-7/8" H x 9" Dia., 6 lbs. 400B: 2 Sealed Beam, 8-7/8" H x 8-1/4" Dia., 7 lbs.
--------------------	--

### Specifications:

<b>Voltage:</b>	12V DC or 24V DC
<b>Amp Draw:</b>	400A/400B: 6.5 Amps @ 12V DC
<b>Flash Rate:</b>	100fpm
<b>Lens color:</b>	Amber, Blue, Clear, Red
<b>Mounting:</b>	400A: Permanent mount 400B: Permanent mount, 3/4" pipe mount
<b>Approvals:</b>	400A: SAE J845 Class 1: Amber

PARTS - 400A, 400B	Part #
Lens	134-L
Bulb - 12V	2073-7400
Bulb - 24V	2073-4505
Motor	P4000
Clamp Ring (400B)	4022

## ENTORNO INDUSTRIAL, S.A. DE C.V.

Juan Sarabia No. 205. Col. Nueva Santa María. 02800 México, D.F.  
Tels.: (55) 5356-7206 • Fax: (55) 5356-7209  
e-mail: ventas@entorno-industrial.com • direccion@entorno-industrial.com

www.entorno-industrial.com



# DASH LIGHTS

## 1188HM - HOT SHOT II



**1188HM**

The 1188 Series Hotshot II is our most compact portable emergency dash light. A 27 watt halogen bulb combined with a highly polished reflector gives this light a high intensity flash. Ships complete with mounting hardware and instructions.

**Models:**

**1188 Series:** 1188H: Permanent Mount; 1188HM: Magnetic Mount  
4-3/4" H x 4-7/8" Dia., 2 lbs.

**Specifications:**

**Voltage:** 12V DC  
**Amp Draw:** 2.1 Amps (27 watts)  
**Flash Rate:** 80fpm(+/-10)  
**Lens Color:** Amber, Blue, Clear, Green, Red, Magenta  
**Mounting:** Permanent Mount, Magnetic Mount

**PARTS**

	Part #
Bulb Halogen.....	2073-H27
Lens.....	396
Cig plug with lighted On/Off Switch.....	176-SW
Vinyl Shield.....	90075

## 1166HM - TEARDROP



**1166HM**

The aerodynamic 1166 Series light is ideal for unmarked cars or volunteers. Ships complete with mounting hardware, cig plug with lighted On/Off switch, and instructions.

**Models:**

**1166 Series:** 1166IM: Incandescent; 1166HM: Halogen  
4-7/8" H x 5-5/16" W x 6-3/4" D, 2.5 lbs.

**Specifications:**

**Voltage:** 12V DC  
**Amp Draw:** Incandescent: 2.7 Amps (35 watts)  
 Halogen: 4.0 Amps (50 watts)  
**Flash Rate:** 160fpm(+/-10)  
**Lens Color:** Amber, Blue, Clear, Green, Red  
**Mounting:** Magnetic Mount

**PARTS**

	Part #
Bulb	
Halogen.....	2073-795X
Incandescent.....	2073-1295
Lens.....	425
Clamp ring.....	30165-2
Cig plug with lighted On/Off Switch.....	176-SW
Vinyl Shield.....	90059

## 1169HM - PANCAKE



**1169HM**

The halogen 1169 Series light features a low profile design, allowing it to fit under sloping windshields with minimum obstruction and maximum visibility. It also features a wide angle reflector for longer flash duration and brighter pulse. Ships complete with mounting hardware, 60 lb. pull magnet, and a cig plug with lighted On/Off switch.

**Models:**

**1169 Series:** 1169H: Permanent Mount; 1169HM: Magnetic Mount  
3-19/32" H x 7-15/64" Dia., 2 lbs.

**Specifications:**

**Voltage:** 12V DC  
**Amp Draw:** 4.0 Amps (50 watts)  
**Flash Rate:** 80fpm(+/-10)  
**Lens Color:** Amber, Blue, Clear, Green, Red  
**Mounting:** Permanent Mount, Magnetic Mount

**PARTS**

	Part #
Bulb Halogen.....	2073-797
Lens.....	393
Cig plug with lighted On/Off Switch.....	176-SW
Vinyl Shield.....	90068

## DASH MOUNTING BRACKETS



**274-874 Suction Cup Bracket**  
 Size: 4"W x 11"D (adjustable plate)  
 Weight: 4 lbs.

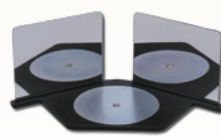

**274-875 Universal Dash Bracket**  
 Size: 4-1/2"H x 11-3/8"W x 5-3/4"D  
 Weight: 4 lbs.



**274-878 Hotshot II Dash Bracket**  
 Size: 4-3/4"H x 10-3/8"W x 5"D  
 Weight: 4 lbs.

**ENTORNO INDUSTRIAL, S.A. DE C.V.**

Juan Sarabia No. 205. Col. Nueva Santa María. 02800 México, D.F.  
 Tels.: (55) 5356-7206 • Fax: (55) 5356-7209  
 e-mail: ventas@entorno-industrial.com • direccion@entorno-industrial.com

www.entorno-industrial.com



# FLASHING BEACONS

## 20ZI/21ZI SERIES - VERY LOW PROFILE



The 20ZI and 21ZI Series are our most popular flashing incandescent lights. On the 20ZI, the polycarbonate lens is clamped to the rugged die-cast aluminum base with a fully gasketed aluminum retaining ring to enhance water resistance. The 21ZI Series offers a quick snap lens and a high impact resistant polycarbonate plastic base assembly for easy field repairs. The polycarbonate lens is sealed to the base with a water resistant enhanced O-ring. Available in steady burn. Ships complete with mounting hardware and instructions.

### Models:

<b>20ZI Series:</b>	20ZI: Permanent Mount; 20ZIM: Magnetic Mount 3-3/4"H x 4-1/8" Dia., 2 lbs.
<b>21ZI Series:</b>	21ZI: Permanent Mount; 21ZIM: Magnetic Mount 3-3/4"H x 4-1/8" Dia., 2 lbs.

### Specifications:

<b>Voltage:</b>	12V DC (available 24V, 36V, 48V DC, or 110V-120V AC)
<b>Amp Draw:</b>	1 Amp @ 12V, 24V, 36V, 48V DC 0.2 Amps @ 110V-120V AC
<b>Output:</b>	15cp - 50cp
<b>Lens color:</b>	Amber, Blue, Clear, Green, Red, Magenta
<b>Mounting:</b>	Permanent Mount 1/2" Pipe Mount Magnetic Mount

PARTS	Part #
Lens (20ZI Series) .....	330
Lens (21ZI Series) .....	330_1
Bulb	
12V .....	2073-94
24V .....	2073-1638
36V .....	2073-1062
110/120V AC .....	2073-15T7DC
Circuit .....	181-FI-12
Cord/Plug* .....	176-SW
Clamp Ring .....	365-Z

(\*Standard on 20ZIM/21ZIM Series only).

## 20FI SERIES - MEDIUM PROFILE



20FI-1 Series

The 20FI Series is a medium profile flashing incandescent light. The polycarbonate lens is clamped to the rugged die-cast aluminum base with a fully gasketed aluminum retaining ring to enhance water resistance. An economical choice for many applications, also available in steady burn. Ships complete with mounting hardware and instructions.

### Models:

<b>20FI Series:</b>	20FI: Permanent Mount 20FI-1: Permanent Mount w/Clear Outer Dome 6-1/16"H x 6-1/16" Dia., 3 lbs.
---------------------	--

### Specifications:

<b>Voltage:</b>	12V DC (available 24V, 36V, 48V DC, or 110V-120V AC)
<b>Amp Draw:</b>	1 Amp @ 12V, 24V, 36V, 48V DC 0.2 Amps @ 110V-120V AC
<b>Output:</b>	15cp - 50cp
<b>Lens color:</b>	Amber, Blue, Clear, Green, Red, Magenta
<b>Mounting:</b>	Permanent Mount 1/2" Pipe Mount

PARTS	Part#
Outer Dome .....	325-L
Lens .....	333
Bulb	
12V .....	2073-94
24V .....	2073-1638
36V .....	2073-1062
110/120V AC .....	2073-40T8DC
Circuit .....	181-FI-12
Clamp Ring .....	4123
Base .....	4100

## ENTORNO INDUSTRIAL, S.A. DE C.V.

Juan Sarabia No. 205. Col. Nueva Santa María. 02800 México, D.F.  
Tels.: (55) 5356-7206 • Fax: (55) 5356-7209  
e-mail: ventas@entorno-industrial.com • direccion@entorno-industrial.com

www.entorno-industrial.com





# FLASHING BEACONS

## 747 SERIES - BARRICADE LIGHT



747

The 747 Series barricade lights offer the thickest case in the industry giving them a damage resistant reputation. They will provide years of service even through severe climate conditions and abuse. The circuit is completely encapsulated for increased shock and weather resistance. Operates with standard 6V spring-terminal batteries (not included). Ships complete with 3-1/4" bolt, nut, and protective cup for mounting (3-3/4", 4" or 5" bolts available).

### Models:

**747 Series:** 747: Standard; 747-PC: With Photocell  
747LED: With LED and Photocell  
12-1/8"H x 7-1/8"W x 3-7/16"D, 2 lb.

### Specifications:

**Voltage:** Flashing: 6V or 12V DC  
Steady Burn: 6V DC

**Amp Draw:** .07 - .13 Amps

**Output:** .19 - .8cp

**Lens Color:** Amber (standard), Blue, Clear, Green, Red

**Case Color:** Orange (standard), Blue, White, Green, Red, Black, Yellow

**Mounting:** Portable

**Approvals:** Meets all ITE Specifications for:  
Type A 12V Flashing Warning Lights  
Type C 6V Steady Burn Lights

PARTS	Part #
Battery.....	8100
Bulb	
Steady Burn 6V.....	2073-47
Flashing 6V.....	2073-1850
Flashing 12V.....	2073-1408
Flasher Assembly.....	7130-*
Lens Half.....	7076
Case, Top.....	7101
Case, Bottom.....	7100
Nut Plate.....	7112
Tamperproof Bolt.....	7017.3-1/4
Protective Cup.....	7009
Mounting Bracket.....	7023
Wrench.....	7016-6
Switch Pin.....	30019-9

\*Part number will vary depending on specifics of light.

## 735F SERIES - PORTABLE



735FI

Shown above with Optional Handle and  
Optional Toggle Switch

The 735F Series is an economical, portable flashing incandescent light. It is constructed with a high impact, safety orange, plastic base. A 360 degree polycarbonate plastic lens allows for visibility in all directions. Economical battery operation (approx. 1500 hours). Operates with standard 6V spring-terminal batteries (not included). These lights are not Coast Guard approved.

### Models:

**735-F:** 6V flashing  
**735P-F:** 6V flashing with photocell  
**735-SB:** 6V steady burn  
**735P-SB:** 6V steady burn with photocell  
**735FI:** 12V flashing  
**735FI-PC:** 12V flashing with photocell  
11-3/4"H x 7-1/4"W x 3-1/2"D, 3 lb.

### Specifications:

**Voltage:** Flashing: 6V or 12V DC  
Steady Burn: 6V DC

**Amp Draw:** 0.07 Amps @ 6V steady  
0.09 Amps @ 6V flashing  
0.13 Amps @ 12V

**Output:** .19 - .8cp

**Lens color:** Amber, Blue, Clear, Green, Red, Magenta

**Mounting:** Portable  
Magnetic Mount Available

Note: This light is not Coast Guard approved.

PARTS	Part #
Bulb	
Steady Burn 6V.....	2073-47
Flashing 6V.....	2073-1850
Flashing 12V.....	2073-1408
Flashing Assembly.....	7030-*
Lens.....	300
Switch.....	8222
Handle.....	202-104-1
Battery.....	8100

\*Part number will vary depending on specifics of light.

## ENTORNO INDUSTRIAL, S.A. DE C.V.

Juan Sarabia No. 205. Col. Nueva Santa María. 02800 México, D.F.  
Tels.: (55) 5356-7206 • Fax: (55) 5356-7209  
e-mail: ventas@entorno-industrial.com • direccion@entorno-industrial.com

www.entorno-industrial.com





# LED LIGHTS

## DLXT SERIES THINLINE PERIMETER LED LIGHTS



Thinline Only  
1/2"

At only 1/2" thick, these high intensity LED lights are built with fully encapsulated circuitry and can be mounted just about anywhere, interior or exterior! Available in four different series, these LED heads can be mounted in four different, weather resistant bezel options in either Black or Chrome finishes. Reverse polarity protected and current limiting protection over the entire operating voltage is standard. S-LINK SYSTEM™ is also standard offering synchronizing capability with other STAR LED units. Optional mounting brackets are available for the single rectangular series only. Ships complete with permanent mounting hardware, gaskets, and instructions.

### Models:

#### DLXT Series Standard Warning LED Light

21 Customer selectable flash patterns; including Steady-On  
Colors: See Below

#### DLHT Series Hazard Turn Light

Synchronized flashing warning lights (flashes with turn signal input)

Colors: See Below

20 Customer selectable flash patterns

#### DLTT Series Auxiliary Stop/Tail/Turn LED Light

Dim day time running tail lights (turn bright with brake signal & flash with turn signal)

Colors: Red/Red, White/White, Green/Green, Blue/Blue, Amber/Amber

#### DLNT Series 16 LED Steady Burn Value Head

Down lighting

Colors: Red/Red, White/White, Green/Green, Blue/Blue, Amber/Amber



**Single Black Bezel**  
Surface Mount or mount with  
optional brackets



**Single Chrome Bezel**  
Surface Mount or mount with  
optional brackets

Specific model numbers vary between series and color combinations. Call for details when ordering.

### Specifications:

#### Dimensions:

**Single Bezel:** 2-1/4" H x 5-3/4" W x 1/2" D

**Dual Bezel:** 4" H x 5-3/4" W x 1/2" D

**Triple Bezel:** 5-3/4" H x 5-3/4" W x 1/2" D

#### Voltage:

10V - 16V DC or 24V DC

#### Amp Draw:

0.3 Amps @ 12V DC

0.2 Amps @ 24V DC

#### Colors:

DLXT & DLHT Series: Amber/Amber, Blue/Blue, Green/Green, Red/Red, White/White, Amber/Blue, Amber/Red, Amber/White, Red/Blue, Blue/White, Red/White



**Dual Black Bezel**  
Surface Mount



**Triple Black Bezel**  
Surface Mount



**Oval Black Bezel Surface Mount**  
or use with standard  
6" oval rubber grommets  
(not for use with optional brackets)



**Oval Bezel**  
Easily fits standard  
6" oval rubber grommets.  
(grommets not included. Order part# 527)

## OPTIONAL MOUNT BRACKETS



**274-DLXT-T**  
Bracket for  
Trunk Mounting



**274-DLXT-45**  
Bracket for 45°  
Angle Mounting



**274-DLXT-U**  
L-Bracket for  
Universal Mounting



**274-DLXT-W**  
Bracket for  
Window Mounting



**274-DLXT-2X1**  
L-Bracket for Mounting  
Two Single Bezel Series  
LED Lights Vertically



**274-DLXT-1X2**  
L-Bracket for Mounting Two  
Single Bezel Series LED Lights Horizontally



**274-DLXT-RL**  
Bracket for License Plate Mounting

## ENTORNO INDUSTRIAL, S.A. DE C.V.

Juan Sarabia No. 205. Col. Nueva Santa Maria. 02800 México, D.F.  
Tels.: (55) 5356-7206 • Fax: (55) 5356-7209  
e-mail: ventas@entorno-industrial.com • direccion@entorno-industrial.com

www.entorno-industrial.com



**DLX4 & DLX6 SERIES VERSASTAR® LED LIGHTS**



**DLX4**



**DLX6**



**DLX4-HK**



**Cig Plug includes Pattern Select and On/Off Switches**



**DLX4-HK2**



**DLX6-HK2**



**DLX6-HK2**

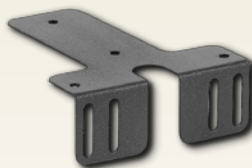

**274-DLX4-6-H**  
Optional Headliner Bracket for DLX4-HK, DLX4-HK2, DLX6-HK, and DLX6-HK2 Series with a Flashback Hood

VersaStar®DLX4 Series & DLX6 Series are versatile LED Warning Lights that are built with fully encapsulated circuitry and can be mounted just about anywhere, interior or exterior! DLX4s & DLX6s are the same size which allows for easy relocation or reconfiguration. The DLX4s are designed for flush or bracket mounting while the DLX6s are designed for bracket mounting only. The DLX6 also incorporates a heavy duty heat sink. Both series include the same snap on bezel or are available with flashback hoods that include either a cig plug adapter or with a 12' wire harness. These high intensity LED lights are reverse polarity protected and current limiting protection over the entire operating voltage is standard. S-LINK SYSTEM™ is also standard offering synchronizing capability with other STAR LED units along with 21 customer selectable flash patterns that give these LED lights versatility in the field. Optional mounting brackets are available. Ships complete with permanent mounting hardware, gaskets, and instructions.

**Models:**

- DLX4:** 4 array LED head with Black Bezel
- DLX4C:** 4 array LED head with Chrome Bezel
- DLX4W:** 4 array LED head with Clear Bezel
- DLX4-HK:** 4 array LED head with Flashback Hood, cig plug adapter
- DLX4-HK-1:** 4 array LED head with Flashback Hood, 12' wire harness
- DLX4-HK2:** Dual 4 array LED heads with Flashback Hood, cig plug adapter
- DLX4-HK2-1:** Dual 4 array LED heads with Flashback Hood, 12' wire harness
- DLX6:** 6 array LED head with Black Bezel
- DLX6C:** 6 array LED head with Chrome Bezel
- DLX6W:** 6 array LED head with Clear Bezel
- DLX6-HK:** 6 array LED head with Flashback Hood, cig plug adapter
- DLX6-HK-1:** 6 array LED head with Flashback Hood, 12' wire harness
- DLX6-HK2:** Dual 6 array LED heads with Flashback Hood, cig plug adapter
- DLX6-HK2-1:** Dual 6 array LED heads with Flashback Hood, 12' wire harness

**Specifications:**

- Dimensions:** 1" H x 3-5/8" W x 3/4" D (single units)
- Voltage:** 10V - 30V DC
- Amp Draw:** DLX4: 0.7 Amps @ 12V DC, 0.3 @ 24V DC  
DLX6: 0.9 Amps @ 12V DC, 0.5 @ 24V DC
- Color Combinations:** Amber/Amber, Blue/Blue, Green/Green, Red/Red, White/White, Amber/Blue, Amber/Red, Amber/White, Red/Blue, Red/White, Blue/White
- Approvals:** DLX4: Class I, California Title 13 (Amber, Blue, Red, White)  
DLX6: Class I, California Title 13 (Amber, Blue, Red, White, Red/Blue)

**OPTIONAL MOUNTING BRACKETS**



**274-DLX4-6-T**  
Bracket for Trunk Mounting



**274-DLX4-6-45**  
Bracket for 45° Angle Mounting

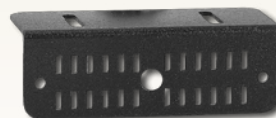

**274-DLX4-6-U**  
L-Bracket for Universal Mounting



**274-DLX4-6-W**  
Bracket for Window Mounting

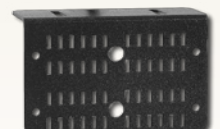

**274-DLX4-6-2X1**  
L-Bracket for Mounting Two DLX4 or DLX6 LED Lights Vertically

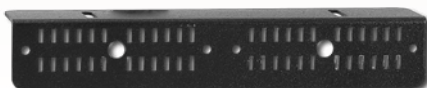

**274-DLX4-6-1X2**  
L-Bracket for Mounting Two DLX4 or DLX6 LED Lights Horizontally



**274-DLX4-6-RL**  
Bracket for License Plate Mounting



## DLX3 SERIES - AUXILIARY LIGHT



DLX3

The patented DLX3 series LED auxiliary light is a small and powerful weather resistant package perfect for mounting on motorcycle saddlebags, in trunks, on vehicle fenders, mirrors, or any place a small intense LED light is needed. Using STAR generation-4 LEDs it has current limit protection over the entire operating voltage range and reverse polarity protection gives you worry free operation. S-LINK SYSTEM™ is standard offering synchronizing capability with other STAR LED units. High/Low power select and 21 different customer selectable flash patterns are available, including a Steady On, for many customized possibilities. Ships complete with 3' attached wire harness, gasket, hardware, and instructions.

### Specifications:

<b>Dimensions:</b>	1" H x 3-5/8" W x 3/4" D (single units)
<b>Weight:</b>	Less than 1 lb.
<b>Voltage:</b>	10V - 16V DC
<b>Amp Draw*:</b>	0.29 Amps
<b>Colors:</b>	Amber, Blue, Red, White, Green
<b>Approvals:</b>	SAE J595, J1318 Class I, California Title 13 (Red, Blue)

\*Amp draw will vary depending on the color of the LED heads used and the flash pattern selected.

## M-TECH® DL SERIES - DASH/DECK LED LIGHTS



DL35-6

The M-Tech® series LED lights are the latest to incorporate highly efficient optics. Designed for interior dash, deck, or window mounting. The DL35 series LED lights offer an extremely wide light distribution. Choose from single or double LED head units. They offer customer selectable flash patterns, reverse polarity protection, and auto-voltage adjustment (10V - 16V DC). S-LINK SYSTEM™ is standard offering synchronizing capability with other STAR LED units. The circuitry is encased in a durable polycarbonate plastic housing that includes a flashback reduction hood. Rated for up to 100,000 hours of use with an extremely low amp draw. These units are ideal for all types of emergency vehicles. They are shipped complete with mounting hardware and instructions.

### Models:

**DL35-6:** Cigarette plug adapter w/lighted on/off switch, 35 Customer selectable flash patterns, flash pattern select button, dual color availability.

**DL35-6-1:** 12' - Four conductor wire harness, synchronizing capabilities, 4 Flash phases, 22 Customer selectable flash patterns, flash pattern select button, dual color availability.

**DL35-12:** Cigarette plug adapter w/lighted on/off switch, 35 Customer selectable flash patterns (two patterns keep RED side on steady to meet certain state requirements), flash pattern select button, single color for each head.

**DL35-12-1:** 12' - Four conductor wire harness, synchronizing capabilities, 4 Flash phases, 22 Customer selectable flash patterns (two patterns keep RED side on steady to meet certain state requirements), flash pattern select button, single color for each head.

### Specifications:

<b>Size:</b>	<b>DL35-6 Series:</b> 2"H x 6"W x 5"D
	<b>DL35-12 Series:</b> 2"H x 12"W x 5"D
<b>Weight:</b>	Less than 2 lbs.
<b>Voltage:</b>	10V - 16V DC
<b>Amp Draw:</b>	<b>DL35-6 Series:</b> 0.4 Amps (max)
	<b>DL35-12 Series:</b> 0.8 Amps (max)
<b>Colors:</b>	Amber, Blue, Green, Red, White
<b>Approvals:</b>	<b>DL35-6:</b> SAE Class I Red or Blue
	<b>DL35-12:</b> SAE Class I Red/Blue, Red or Blue



DL35-6-1



DL35-12



DL35-12-1

**STARBURST™ DL15 SERIES - INTERIOR/EXTERIOR**

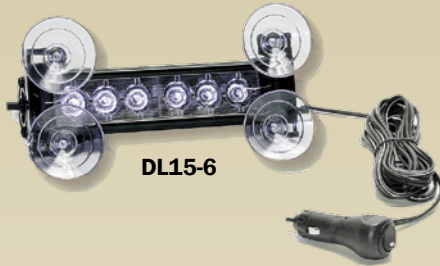

**DL15-6**

The STARBURST™ series LED lights are compact, durable, and powerful. Designed for dash, deck, window, mirror, or grille mounting. The DL15 series LED lights are high intensity, STAR generation-3 LED lights, offered in 6" or 11" widths and are rotationally adjustable. Customer selectable flash patterns, reverse polarity protection, and auto-voltage adjustment (10V - 16V DC). S-LINK SYSTEM™ is standard offering synchronizing capability with other STAR LED units. The circuitry is encased in a rugged extruded aluminum housing for protection against shock and vibration. Rated for up to 100,000 hours of use with an extremely low amp draw. These units are ideal for all types of emergency vehicles. They are shipped complete with suction cups, 3 different sets of mounting legs, and instructions.



**DL15-6W-1K**

**Models:**

**DL15-6:** Interior mount only, 6 LED array unit, cig plug with lighted on/off switch, pattern select switch, 30 different customer selectable flash patterns.

**DL15-6W:** Interior/Exterior mount, 6 LED array unit, weatherproof 12' three conductor cable, 30 different customer selectable flash patterns.

**DL15-6W-1K:** Interior/Exterior mount synchronized kit, one pair of 6 LED array units (two DL15-6W-1 units that can be synchronized for Simultaneous or Alternating flashing), weatherproof 12' three conductor cables, 3 different customer selectable flash patterns.

**DL15-6MMB:** Interior mount only kit, mirror mount bracket, 6 LED array unit, cig plug with lighted on/off switch, pattern select switch, 30 different customer selectable flash patterns.



**DL15-12**

**DL15-6GMB:** Interior/Exterior mount, grille mount bracket, 6 LED array unit, weatherproof connector, 12' three conductor cable, 30 different customer selectable flash patterns.

**DL15-12:** Interior mount only, 12 LED array unit, cig plug with lighted on/off switch, pattern select switch, 35 different customer selectable flash patterns.

**DL15-12W:** Interior/Exterior mount, 12 LED array unit, weatherproof 12' three conductor cable, 35 different customer selectable flash patterns.



**DL15-6MMB**

**Specifications:**

**Size:** **DL15-6 Series:** 1-9/16"H x 6"W x 1-5/16"D  
**DL15-12 Series:** 1-9/16"H x 11"W x 1-5/16"D

**Weight:** Less than 2 lbs.

**Voltage:** 10V - 16V DC

**Amp Draw\*:** DL15-6: 0.8 Amps  
DL15-12: 1.6 Amps

**Colors:** Amber, Blue, Red, White, Green

**Mounting Options†:** Suction cups  
Universal mounting channel  
5" permanent mount legs (over third brake light)  
2-7/8" permanent mount legs  
1-3/4" permanent mount legs  
Grille Mount  
Mirror Mount  
†suction cups and all mounting legs are included (DL15-BKT)

**Approvals:** SAE J595, SAE J1318 Class I, and California Title 13 for RED and BLUE  
(\*Does not apply to all flash patterns)

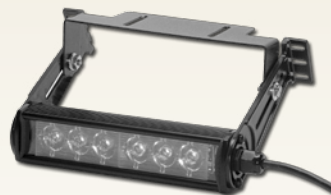

**DL15-6GMB**

PARTS	Part #
Universal mount kit.....	DL15-BKT
Deck mount kit.....	DL15-SMTK
Suction cup kit (four).....	DL15-CUPK
Suction cup (one).....	DL15-CUP
Grille mount bracket kit.....	274-DL15GMB
Mirror mount bracket kit.....	274-DL15MMB



# LED LIGHTS

## ULB9 - STAR MINI-PHANTOM® UNDERCOVER LED LIGHT

Now with 22% more LEDs!



**ULB9**

Shown with available flashback hood



Mirror Mount



Deck Mount



Suction Cup Mount



Available: **274-ULB9CH**  
Dodge Charger Headliner Bracket

PARTS ULB9	Part #
Suction Cup (One).....	DL15-CUP
Complete Universal Mount Kit.....	274-ULB9BKT
Cig Plug w/Lighted On/Off Switch and pattern select .....	P920-PAT20LO

The patented STAR Mini-Phantom®, interior mount, LED light is perfect for undercover or unmarked vehicle applications. The ULB9 has an extremely thin profile, less than 1" high, that easily mounts to your dash, deck, mirror, or windows (with suction cups). At only 9" long, the 66 long life, alternate flashing LEDs give the STAR Mini-Phantom® the power and flexibility you need with 35 customer selectable flash patterns with the push of a button. The ULB9 is also available with a 12' hardwire lead version that will synchronize with other ULB9's (Model# ULB9-1). S-LINK SYSTEM™ is standard offering synchronizing capability with other STAR LED units. A two head kit is also available (RLKULB9-1) that offers 6 customer selectable flash patterns. The ULB9 ships complete with cig plug with lighted On/Off switch, 3 versatile mount options (suction cup mount, rear view mirror mount, and dash or deck mount), hardware, and instructions.

### Models:

- ULB9:** Cig plug with lighted on/off switch and pattern select
- ULB9-1:** 12' wire leads
- RLKULB9-1:** ULB9-1 Kit consisting of two ULB9-1's 15' wire leads

### Specifications:

- Size:** 15/16"H x 9"W x 1-3/8"D
- Weight:** Less than 1 lb.
- Voltage:** 10-16V DC
- Amp Draw\*:** 1.4 Amps Max
- Color Combinations:** Amber, Blue, Green, Red, White

\*Amp draw will vary depending on the color of the LED heads used and the flash pattern selected.

## ULB9S - STARBURST MINI-PHANTOM® UNDERCOVER LED LIGHT

Now with Generation IV LEDs



Mirror Mount



Deck Mount



Suction Cup Mount



Available: **274-ULB9CH**  
Dodge Charger Headliner Bracket

PARTS ULB9S	Part #
Suction Cup (One).....	DL15-CUP
Complete Universal Mount Kit.....	274-ULB9BKT
Cig Plug w/Lighted On/Off Switch and pattern select .....	P920-PAT20LO

Star Signal Vehicle Products is proud to introduce the new ULB9S Starburst Mini-Phantom Undercover LED Light. Ideal for unmarked vehicles, the ULB9S is equipped with 6 Generation IV StarBurst LEDs and with its slim profile stands less than 1" high. The ULB9S is also available in single or dual colors and comes equipped with 35 customer selectable flash patterns via the rocker switch on the cigarette plug. The ULB9S is easily customizable, with a 12' cable that will synchronize with any other STAR LED light (Model# ULB9S-1). A two head kit is also available (RLKULB9S-1) that offers 6 customer selectable flash patterns. In addition, this newest addition to the Phantom series ships complete with 3 versatile mount options (suction cup, rear view mirror and dash or deck).

### Models:

- ULB9S:** Cig plug with lighted on/off switch and pattern select
- ULB9S-1:** 12' wire leads
- RLKULB9S-1:** ULB9S-1 Kit consisting of two ULB9S-1's 15' wire leads

### Specifications:

- Size:** 15/16"H x 9"W x 1-3/8"D
- Weight:** Less than 1 lb.
- Voltage:** 10-16V DC
- Amp Draw\*:** 1.4 Amps Max
- Color Combinations:** Amber, Blue, Green, Red, White

\*Amp draw will vary depending on the color of the LED heads used and the flash pattern selected.

## ENTORNO INDUSTRIAL, S.A. DE C.V.

Juan Sarabia No. 205. Col. Nueva Santa María. 02800 México, D.F.  
Tels.: (55) 5356-7206 • Fax: (55) 5356-7209  
e-mail: ventas@entorno-industrial.com • direccion@entorno-industrial.com

www.entorno-industrial.com





## LDHEF SERIES - ROUND & OVAL



**LDHEF-4**



**LDHEF-4MR**



**LDHEF-6**



**LDHEF-3K**

Designed Specifically for Mounting Under Trunk Lids  
Standard kit includes:  
(2) LDHEF-3 LED heads with mounting brackets

These self-contained, flashing LED heads with built-in flashers are ready for quick installation in any situation. The 4" round LED head is available with a rubber grommet, rubber housing with brackets for trunk mounting, or with an anti-theft, bright stainless steel ring for easy snap-in installation. All LDHEF series LED heads offer customer selectable flash sequences of Random or Alternating in a completely encapsulated solid state circuit to protect against moisture and contaminates, and are synchronizable. The LED circuitry is encased in a high impact resistant, polycarbonate housing for protection against shock and vibration. Rated for up to 100,000 hours of use with an extremely low amp draw and protected against voltage spikes. These units are ideal for all types of emergency vehicles. They are shipped complete with pigtail and instructions.

### Specifications:

<b>Size:</b>	<b>LDHEF-4 Series:</b> 4"Dia. x 2"D
	<b>LDHEF-6 Series:</b> 2-1/2"H x 6-1/2"W x 2"D
<b>Weight:</b>	0.5 lb.
<b>Voltage:</b>	12V - 24V DC
<b>Amp Draw:</b>	Less than 0.8 Amps
<b>Flash Rate:</b>	72 Quint (5) flashes per minute
<b>Operating Temp.:</b>	-22° F to + 149° F
<b>Colors:</b>	Amber, Red, Clear, Blue
<b>Approvals:</b>	SAE J1318 Class 1: Amber, Red, Blue
<b>Non-Flashing LED Heads are available:</b>	4" Round: Part# LDH394 6" Oval: Part# LDH392
<b>Anti-theft, bright stainless steel ring with neoprene gasket:</b>	Ring Kit: Part# 30019-99

## PAR 36 SELF-CONTAINED ROUND LED



### Specifications:

- High efficiency optics available in two options:
  1. Spot (3 degrees)
  2. Trapezoidal
- Lens Colors: Amber, Blue, Clear, Green and Red
- Six Gen IV LEDs
- Voltage: 10-30V DC
- Thermal protection
- Five mounting options:
  1. Swivel Bracket
  2. Rubber Tractor Housing
  3. Direct Par 36 Sealed Beam Replacement including 4411 and 4411-1 style seal beam
  4. Rubber grommet
  5. Truck Housing w/magnet & Cig plug
- 1,200 Lumens (White 5000K Color Temperature)
- SAE Class 1, California Title 13
- Patent Pending

### Steady Burn Lights Only (LDH-36 Series):

- SO 7637-2 spike protection

### Flashing and Hazard Turn Lights Only (LDHF36 and LDHT36 Series):

- S-Link System™ synchronizing compatability
- Available in Red and Blue LEDs with clear lens
- 32 patterns plus steady burn
- Added turn signal input in order to over ride warning pattern (LDHT36 only)



# REMOTE KITS & HEADS

## HIDE-A-STAR™ IN-LINE REMOTE FLASHING LED KITS

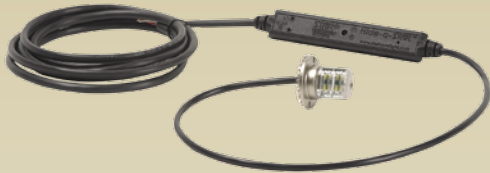

**LDHF301 Series**  
Directional Head



**LDHF311 Series**  
Spherical Head

Hide-A-STAR™ in-line remote flashing LED kits are designed with NEW LED technology and self-contained, LED flashing circuitry. No need for a remote flasher module! The optics boost and concentrate light for maximum LED output. The spherical LED heads are designed with diffusing optics for extremely wide angle light. Nickel plated aluminum housings allow for our advanced thermal heat management and easily replace standard hide-away remote strobe tubes with 1" mounting holes. S-LINK SYSTEM™ is standard offering synchronizing capability with other STAR LED units. 25 customer selectable flash patterns along with customer changeable colored lenses gives these LED lights versatility in the field. Ships complete with mounting hardware, one each colored lens, and instructions.

**LDHF301 Series Kits:**  
Available in two cable lengths:  
LDHF301.\*-10: 10' Cable  
LDHF301.\*-30: 30' Cable

**LDHF311 Series Kits:**  
Available in two cable lengths:  
LDHF311.\*-10: 10' Cable  
LDHF311.\*-30: 30' Cable

### Specifications:

**Amp Draw:** 0.5 amps per head (max)  
**Voltage:** 12V-24V DC  
**Lens Colors:** Amber, Blue, Green, Red, or Clear  
**Mounting:** 1" Hole

## HIDE-A-STAR™ REMOTE FLASHING LED KITS

Hide-A-STAR™ remote flashing LED kits are designed with NEW LED technology. The optics boost and concentrate light for maximum LED output. The spherical LED heads are designed with diffusing optics for extremely wide angle light. Nickel plated aluminum housings allow for our advanced thermal heat management and easily replace standard hide-away remote strobe tubes with 1" mounting holes. S-LINK SYSTEM™ is standard offering synchronizing capability with other STAR LED units. 20 customer selectable flash patterns along with customer changeable colored lenses give these LED lights versatility in the field. Each kit ships complete with mounting hardware, one each colored lens, and instructions.



**LDK302 Series**  
Directional Head



**LDK312 Series**  
Spherical Head

**LDK302 Two Head LED Kit Includes:**  
1 - Flasher module  
1 - 4' Cable with attached connectors  
1 - 8' Cable with attached connectors  
2 - LED head assemblies with 2' leads and attached connectors

**LDK304 Four Head LED Kit Includes:**  
2 - Flasher modules  
2 - 4' Cables with attached connectors  
2 - 8' Cables with attached connectors  
4 - LED head assemblies with 2' leads and attached connectors

**LDK312 Two Head LED Kit Includes:**  
1 - Flasher module  
1 - 4' Cable with attached connectors  
1 - 8' Cable with attached connectors  
2 - LED Spherical head assemblies w/ 2' leads and attached connectors

**LDK314 Four Head LED Kit Includes:**  
2 - Flasher modules  
2 - 4' Cables with attached connectors  
2 - 8' Cables with attached connectors  
4 - LED Spherical head assemblies w/ 2' leads and attached connectors

### Specifications:

**Optional Code Lengths:** 15', 20', 25', 30', or 35'  
**Voltage:** 12V - 24V DC  
**Amp Draw:** 0.5 amps per head (max)  
**Lens Color:** Amber, Blue, Green, Red, or Clear  
**Mounting:** 1" Hole

## ENTORNO INDUSTRIAL, S.A. DE C.V.

Juan Sarabia No. 205. Col. Nueva Santa María. 02800 México, D.F.  
Tels.: (55) 5356-7206 • Fax: (55) 5356-7209  
e-mail: ventas@entorno-industrial.com • direccion@entorno-industrial.com

www.entorno-industrial.com



# REMOTE KITS & HEADS

## RSK SERIES REMOTE STROBE KITS

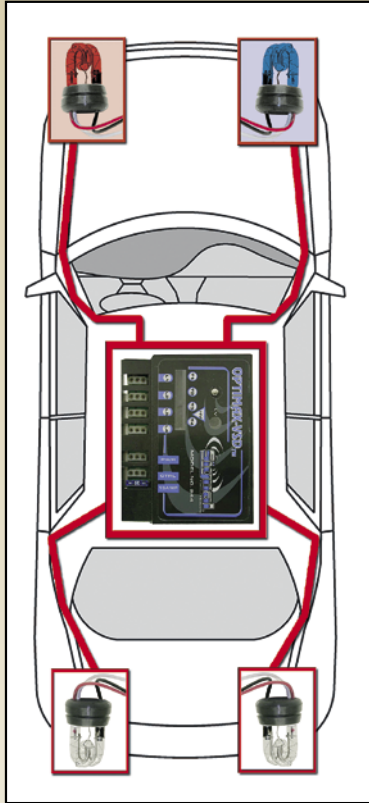

Whether you choose the OPTIMAX™ or the STAR-PAK®, you have a quality remote power supply kit that is built to last. These kits include power supplies that are offered in a wide range of output from 20 watts to 90 watts and can control from 2 to 6 remote strobe heads or flash tubes and, depending on the model you choose, interior or exterior mount. Several models offer selectable flash patterns and visual diagnostics, as well as day/night mode selections. Kits include, remote power supply, strobe heads, standard length cables, and lighted toggle switches. Display boxed kits are also available.

In the unlikely event that your system fails to operate properly, the Visual System Diagnostics (VSD™) helps diagnose the problem for RP244, RP966, and RP996. By observing a series of miniature lamps through windows located on the power supply you can evaluate four important operations of the strobe system:

1. The low voltage (input voltage)
2. The high voltage (output voltage)
3. The trigger lines (power going to strobe tubes)
4. The strobe heads enabled



**ST413PA**

Amber Strobe Tube



**ST415PC**

Clear Strobe Tube



**ST413PR**

Red Strobe Tube



**ST413PB**

Blue Strobe Tube

The PHANTOM™ STROBE TUBES are designed to mount into headlight, tail light, or marker light housings allowing your vehicle to blend in with traffic until you are ready to be noticed.



**RSK244P**

## OPTIMAX-VSD™ RSK244P 75 WATT KIT

The OPTIMAX-VSD™ RSK244P remote strobe kit is a complete, powerful, and economical choice for a 4-corner remote strobe system. Six different customer selectable flash patterns (Single, Double, Triple, Quad, Five, or Random) are available, along with head selection and Day/Night mode. Features power reduction to operating heads in case of head failure. Ships complete with power & control leads and instructions. Display packaging is available: RSK244P-1.

### Standard Kit Includes:

- |              |                                     |
|--------------|-------------------------------------|
| (1) RP244:   | 75 Watt remote power supply         |
| (4) ST415PC: | Clear strobe tube assemblies        |
| (2) 4415:    | 15' Cables with attached connectors |
| (2) 4420:    | 20' Cables with attached connectors |
| (1) LT1511:  | Lighted toggle switch               |



**RSK242P**

## OPTIMAX™ RSK242P 40 WATT KIT

The OPTIMAX™ RSK242P remote strobe kit is an ideal choice where only two PHANTOM™ strobe tubes are needed. You can select flash patterns of Single, Double, Triple, Quad, Five, or Random. Customer selectable Day/Night mode. Ships complete with power & control leads and instructions. Display packaging is available: RSK242P-1.

### Standard Kit Includes:

- |              |                                     |
|--------------|-------------------------------------|
| (1) RP242:   | 40 Watt remote power supply         |
| (2) ST415PC: | Clear strobe tube assemblies        |
| (2) 4415:    | 15' Cables with attached connectors |
| (1) LT1511:  | Lighted toggle switch               |

## ENTORNO INDUSTRIAL, S.A. DE C.V.

Juan Sarabia No. 205. Col. Nueva Santa María. 02800 México, D.F.  
Tels.: (55) 5356-7206 • Fax: (55) 5356-7209  
e-mail: ventas@entorno-industrial.com • direccion@entorno-industrial.com

www.entorno-industrial.com





# REMOTE KITS & HEADS

## STAR-PAK® RSK310P 24 WATT KIT

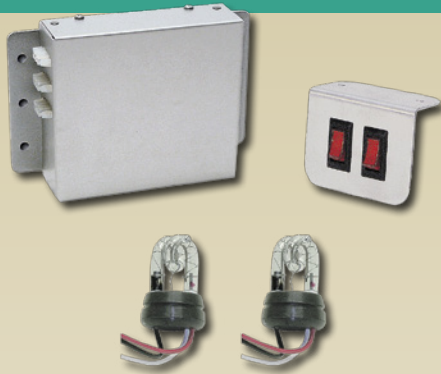

RSK310P

The STAR-PAK® RSK310P remote strobe kit is an ideal choice where only two PHANTOM™ strobe tubes are needed. A fully encapsulated circuit board resists elements. Standard Quad Flash. Customer selectable Day/Night mode. Ships complete with power lead and instructions.

### Standard Kit Includes:

- (1) **RP310Q:** 24 Watt remote power supply
- (2) **ST3901:** Clear strobe tube assemblies
- (2) **3820-180":** 15' Cables with attached connectors
- (1) **SP3860-2H:** Lighted rocker switch panel

## STAR-PAK® RSK966P 60 WATT KIT



RSK966P

The STAR-PAK® RSK966P remote strobe kit incorporates six outlets with 24 customer selectable flash patterns all in a 60 watt system. Multiple strobe head combinations can be enabled. Customer selectable Day/Night mode. Features power reduction to operating heads in case of head failure, RFI protection, and Visual System Diagnostics (VSD™). Ships complete with power & control leads and instructions. 4-head and 6-head kits are available. Display packaging is available: 6-head (RSK966P-1), 4-head (RSK966P-4-1) Available police prep harness kit for 2007 Ford Crown Victoria (RFK996-CV).

### Standard Kit Includes:

- RSK966P:**
- (1) **RP966:** 60 Watt remote power supply
- (6) **ST415PC:** Clear strobe tube assemblies
- (6) **4415:** 15' Cables with attached connectors
- (1) **LT1511:** Lighted toggle switch

- RSK966P-4:**
- (1) **RP966:** 60 Watt remote power supply
- (4) **ST415PC:** Clear strobe tube assemblies
- (2) **4415:** 15' Cables with attached connectors
- (2) **4420:** 20' Cables with attached connectors
- (1) **LT1511:** Lighted toggle switch

## STAR-PAK® RSK996P 90 WATT KIT



RSK996P

The STAR-PAK® RSK996P remote strobe kit incorporates six outlets with 24 customer selectable flash patterns all in a 90 watt system. Multiple strobe head combinations can be enabled. Customer selectable Day/Night mode. Features power reduction to operating heads in case of head failure, RFI protection, cooling fan, and Visual System Diagnostics (VSD™). Ships complete with power & control leads and instructions. 4-head and 6-head kits are available. Display packaging is available: 6-head (RSK996P-1), 4-head (RSK996P-4-1) Available police prep harness kit for 2007 Ford Crown Victoria (RFK996-CV).

### Standard Kit Includes:

- RSK996P:**
- (1) **RP996:** 90 Watt remote power supply
- (6) **ST415PC:** Clear strobe tube assemblies
- (6) **4415:** 15' Cables with attached connectors
- (1) **LT1511:** Lighted toggle switch

- RSK996P-4:**
- (1) **RP996:** 90 Watt remote power supply
- (4) **ST415PC:** Clear strobe tube assemblies
- (2) **4415:** 15' Cables with attached connectors
- (2) **4420:** 20' Cables with attached connectors
- (1) **LT1511:** Lighted toggle switch

## ENTORNO INDUSTRIAL, S.A. DE C.V.

Juan Sarabia No. 205. Col. Nueva Santa María. 02800 México, D.F.  
Tels.: (55) 5356-7206 • Fax: (55) 5356-7209  
e-mail: ventas@entorno-industrial.com • direccion@entorno-industrial.com

www.entorno-industrial.com



# REMOTE KITS & HEADS

## STAR-PAK® RP310D & RP310Q 24 WATT

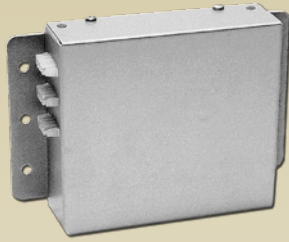

RP310Q

### Models:

RP310D:	Double Flash
RP310Q:	Quad Flash

### Specifications:

Size:	1-3/4"H x 4-3/4"W x 6-3/4"D
Weight:	1 lb.
Outlets:	2
Output:	24 Watts
Voltage:	12V - 24V DC
Amp Draw:	2.5 Amps Max

## OPTIMAX™ RP242 40 WATT

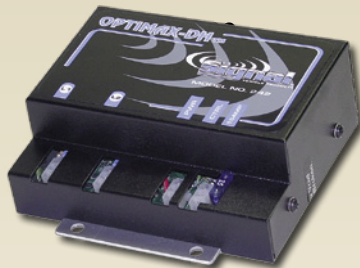

RP242

### Models:

RP242:	User selectable flash pattern
--------	-------------------------------

### Specifications:

Size:	2"H x 5-1/2"L x 4-1/4"D
Weight:	1.25 lbs.
Outlets:	2
Output:	40 Watts
Voltage:	12V - 24V DC
Amp Draw:	4.2 Amps Max

## OPTIMAX™ VSD RP244 75 WATT



RP244

### Models:

RP244:	User selectable flash pattern Head selectability
--------	---

### Specifications:

Size:	2"H x 5-1/2"L x 4-1/4"D
Weight:	1.25 lbs.
Outlets:	4
Output:	75 Watts
Voltage:	12V - 24V DC
Amp Draw:	7.8 Amps Max

## STAR-PAK® RP966 60 WATT & RP996 90 WATT



RP996

### Models:

RP966:	User selectable flash pattern Head selectability
RP996:	User selectable flash pattern Head selectability

### Specifications:

Size:	2-7/8"H x 5-1/2"L x 5-1/4"D
Weight:	1.25 lbs.
Outlets:	6
Output:	RP966: 60 Watts RP996: 90 Watts
Voltage:	12V - 24V DC
Amp Draw:	RP966: 7.8 Amps Max RP996: 9.4 Amps Max

### ENTORNO INDUSTRIAL, S.A. DE C.V.

Juan Sarabia No. 205. Col. Nueva Santa Maria. 02800 México, D.F.  
Tels.: (55) 5356-7206 • Fax: (55) 5356-7209  
e-mail: ventas@entorno-industrial.com • direccion@entorno-industrial.com

www.entorno-industrial.com



# REMOTE KITS & HEADS

## REMOTE STROBE HEADS



A. SH3904



B. SH3920



C. SH3930



D. SH3930E



E. SH3940



F. SH4500



G. SH4501



H. SH4601



I. SH4602



J. SH3970

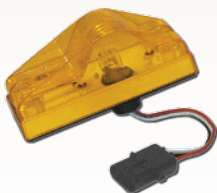

K. SH3922



L. ST415P

### Specifications:

- A. SH3904** Round strobe head  
 Size: 4" Dia. x 2"D  
 Lens color: Amber, Blue, Clear, Red
- B. SH3920** Oval strobe head  
 Size: 2-1/2"H x 6-1/2"W x 2"D  
 Lens color: Amber, Blue, Clear, Red
- C. SH3930** Par-36 round strobe head  
 Size: 4-3/4"Dia. x 2-1/2"D  
 Lens color: Amber, Blue, Clear, Red
- D. SH3930E** Par-36 round with extended lens strobe head  
 Size: 4-3/4"Dia. x 3-1/2"D  
 Lens color: Amber, Blue, Clear, Red
- E. SH3940** 360° 8" strobe head with standard 180" cable (custom length cable is available)  
 Size: 8"H x 5-1/2"Dia.  
 Lens color: Amber, Blue, Clear, Red
- F. SH4500** Mini-rectangular strobe head, black housing  
 Size: 2-3/4"H x 5"L x 2-1/2"D  
 Lens color: Amber, Blue, Clear, Red
- G. SH4501** Rectangular strobe head, black housing  
 Size: 3-1/2"H x 6-1/2"W x 2-1/2"D  
 Lens color: Amber, Blue, Clear, Red
- H. SH4601** 360° 4" strobe head with standard 180" cable (custom length cable is available)  
 Size: 4"H x 5-1/2"Dia.  
 Lens color: Amber, Blue, Clear, Red
- I. SH4602** 360° 6" strobe head with standard 180" cable (custom length cable is available)  
 Size: 6"H x 5-1/2"D  
 Lens color: Amber, Blue, Clear, Red
- J. SH3970** Round, surface mount strobe head  
 Size: 7"Dia. x 2"D  
 Lens color: Amber, Red
- K. SH3922** Side mount strobe head  
 Size: 2-1/2"H x 6"W x 2-1/2"D  
 Lens color: Amber, Red
- L. ST415P** Phantom™ strobe tube assembly  
 Size: 1"Dia.  
 Color: Clear  
 Order ST413 for Amber, Blue or Red

### ENTORNO INDUSTRIAL, S.A. DE C.V.

Juan Sarabia No. 205. Col. Nueva Santa María. 02800 México, D.F.  
 Tels.: (55) 5356-7206 • Fax: (55) 5356-7209  
 e-mail: ventas@entorno-industrial.com • direccion@entorno-industrial.com

www.entorno-industrial.com







# TRAFFIC DIRECTORS

## TD92 & TD93 SERIES

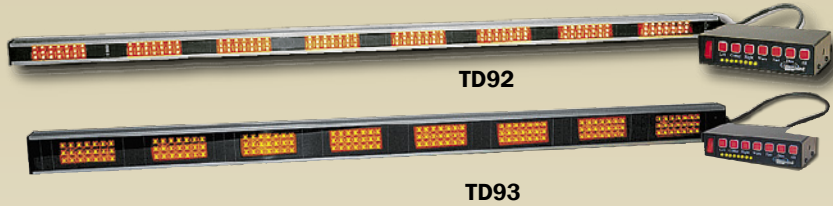

STAR LED Traffic Directors are designed to give you mobile, on-site traffic-directing capabilities. Made from durable extruded aluminum, these traffic directors will not warp or bend. Use them on location for road construction, accident, or roadside repairs to steer traffic away from dangerous situations and roadway hazards. The micro-processor control unit with tactile switching offers four modes with distinctive flash options. Polycarbonate face shields allow for easy cleaning. Ships complete with control unit, attached wire harness (15' standard), mounting brackets, hardware, and instructions.

### Specifications:

<b>Size:</b>	<b>TD77-2 Control Unit:</b>	1-1/2"H x 6"W x 4-1/2"D
	<b>TD92-1 LED Stik:</b>	1-1/2"H x 47-1/2"W x 1-1/2"D
	<b>TD93-1 LED Stik:</b>	2-7/32"H x 47-1/2"W x 1-1/2"D
<b>Weight:</b>	TD92, TD93: 10 lbs.	
<b>Voltage:</b>	12V DC (Available 24V DC)	
<b>Amp Draw:</b>	TD92, TD93:	2.1 Amps (max)
<b>Cable Length:</b>	15', 30', 45', or 60'	
<b>Modes:</b>	Left Arrow, Right Arrow, Center Out, and Warn (Alternating)	

PARTS	PART#
TD92 LED Stick only .....	TD92-1
TD93 LED Stick only .....	TD93-1
Control Unit .....	TD77-2
TD92 L-bracket mount kit .....	TD77-6K
TD93 L-bracket mount kit .....	274-LLBK

## TD93DLXT SERIES

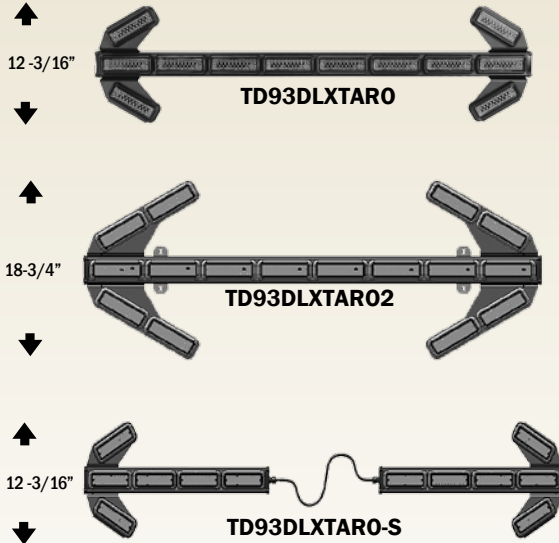

STAR TD93DLXT Series LED Traffic Directors are designed to give you mobile, on-site traffic-directing capabilities. Made from durable extruded aluminum, these traffic directors will not warp or bend. Use them on location for road construction, accident, or roadside repairs to steer traffic away from dangerous situations and roadway hazards. The micro-processor control unit with tactile switching offers four modes with distinctive flash options. Modules "front load" for easy replacement of individual heads! Ships complete with control unit, attached wire harness (15' standard), flush mounting brackets (optional L-Brackets available), hardware, and instructions.

### Models:

<b>TD93DLXT:</b>	Traffic Director with eight LED heads, no arrows
<b>TD93DLXTAR0:</b>	Traffic Director with eight LED heads, arrows with four LED heads
<b>TD93DLXTAR02:</b>	Traffic Director with eight LED heads, arrows with eight LED heads
<b>TD93DLXTAR0-S:</b>	Split Traffic Director with eight LED heads, arrows with four LED heads

### Specifications:

<b>Size:</b>	<b>TD77-2 Control Unit:</b>	1-1/2"H x 6"W x 4-1/2"D
	<b>TD93DLXT-1 LED Stik:</b>	2-7/32"H x 47-1/2"W x 1-1/2"D (less arrows)
<b>Weight:</b>	TD93DLXT: 10lbs.; TD93DLXTAR0: 15lbs.; TD93DLXTAR02: 19lbs.	
<b>Voltage:</b>	12V DC (Available 24V DC, TD93DLXT only)	
<b>Amp Draw:</b>	TD93DLXT:	2.7 Amps (max)
	TD93DLXTAR0, TD93DLXTAR0-S:	4.1 Amps (max)
	TD93DLXTAR02:	4.8 Amps (max)
<b>LED Stik Length:</b>	48", 60", 72", 84" or 96" (excludes TD93DLXTAR0-S)	
<b>Cable Length:</b>	15', 30', 45', or 60'	
<b>Modes:</b>	Left Arrow, Right Arrow, Center Out, and Warn (Alternating)	

PARTS	PART#
TD93DLXT LED Stick only .....	TD93DLXT-1
Control Unit .....	TD77-2
TD93DLXT L-bracket mount kit .....	274-LLBK
TD93DLXT (replacement head) .....	TD93DLXTRH

## ENTORNO INDUSTRIAL, S.A. DE C.V.

Juan Sarabia No. 205. Col. Nueva Santa María. 02800 México, D.F.  
 Tels.: (55) 5356-7206 • Fax: (55) 5356-7209  
 e-mail: ventas@entorno-industrial.com • direccion@entorno-industrial.com

www.entorno-industrial.com



# TRAFFIC DIRECTORS

## TDDL15 SERIES - HIGH INTENSITY LED TRAFFIC DIRECTOR



### TDDL15-42TA

These LED Traffic Directors are designed to give you mobile, on-site traffic-directing capabilities with 24 High Intensity STAR Generation-3 LEDs (8-arrays, 3 LEDs per array). The Black anodized extruded aluminum will not warp or bend. Use them on location for road construction, accident, or roadside repairs to steer traffic away from dangerous situations and roadway hazards. The micro-processor control unit with tactile switching offers four modes with distinctive flash options. Easily mounts with 1/4" groove on back. Polycarbonate face shields allow for easy cleaning. Ships complete with control unit, attached wire harness, mounting brackets, hardware, and instructions. Specific models are available with mounting brackets designed for Chevy Tahoe (TDDL15-42TA with a standard 22' wire harness) and Ford Crown Victoria (TDDL15-47CV with a standard 15' wire harness).



A closer look at the Starburst optics

### Specifications:

<b>Size:</b>	<b>TD77-2 Control Unit:</b> 1-1/2"H x 6"W x 4-1/2"D
	<b>TDDL15-47-1 LED Stik:</b> 1-9/16"H x 47"W x 1-5/16"D
	<b>TDDL15-42-1 LED Stik:</b> 1-9/16"H x 42"W x 1-5/16"D
	<b>TDDL15-36-1 LED Stik:</b> 1-1/2"H x 36"W x 1-5/16"D
<b>Weight:</b>	8 lbs.
<b>Voltage:</b>	10V-16V DC
<b>Amp Draw:</b>	3.0 Amps (max)
<b>Cable Length:</b>	15', 30', 45', or 60'
<b>Modes:</b>	Left Arrow, Right Arrow, Center Out, and Warn (Alternating)

PARTS	PART#
Control Unit.....	TD77-2
TDDL15-47 bracket mount kit.....	274-LLBK
TDDL15-42TA bracket mount kit.....	TD92-7KTA
TDDL15-47CV bracket mount kit.....	DL15-BKTCV

## STARBURST™ DL15-30W SERIES - WARNING/TRAFFIC DIRECTORS



### DL15-30W-ARB

The STARBURST™ DL15-30W series Warning LED light & LED Traffic Director is an all in one, 28", low profile (only 1-9/16" tall), 30 high intensity STAR generation-3, LED unit. It can be used as a warning light with 30 different customer selectable flash patterns or, with the flip of a switch, function as a Traffic Director with 3 different traffic director modes each having six different custom patterns from which to choose. Rotationally adjustable and waterproof, this unit can be utilized in a variety of applications. Current limit protection over entire operating voltage range and reverse polarity protection gives you worry free operation. The STARBURST™ DL15-30W is offered in a variety of colors and color combinations. The DL15-30W can also be used primarily as a Traffic Director. Simply order all Amber LEDs or a color combination of 18 center LEDs Amber and then choose color combinations of RED/RED, RED/BLUE, or BLUE/BLUE for the remaining outer 6 left side and 6 right side LEDs. An optional traffic director switch panel (SP1515-TDC) or Control Box (TD77-2) is available. Ships complete with 15'-six conductor cable, 3 sets of mounting legs, hardware, and instructions.

### Customer Selectable Traffic Director Modes:

3 Modes: Left Arrow, Right Arrow, Center Out

### 6 Patterns for each arrow mode\*:

traveling arrow, traveling arrow with double flashing end module, traveling arrow with continuous alternating flashing end modules (hazard lights) non-traveling arrow, non-traveling arrow with double flashing end module, non-traveling arrow with continuous alternating flashing end modules (hazard lights).

(\*Once a pattern is selected in one of the arrow modes, that "pattern" is automatically changed for the other two modes. Ex. Choose "traveling arrow" while in left arrow mode, automatically, right arrow mode and center-out mode will also be set to "traveling arrow" pattern.)

PARTS	Part #
Deck mount kit.....	DL15-SMTK
Optional traffic director control panel.....	SP1515-TDC
Control Box (with LED feedback).....	TD77-2

### Specifications:

<b>Size:</b>	1-9/16"H x 28"W x 1-5/16"D
<b>Weight:</b>	3 lbs.
<b>Voltage:</b>	10V - 16V DC
<b>Amp Draw*:</b>	4 Amps (max with all LEDs illuminated)
<b>Colors:</b>	All Amber, All Blue, All Red, OR Combinations of: Amber/Blue, Amber/ Red, Red/Blue, Red/White
<b>Mounting Options:</b> (included)	Universal Mounting Channel 5" permanent mount legs 2-7/8" permanent mount legs 1-3/4" permanent mount legs
<b>Approvals:</b>	SAE J595, SAE J1318, and California Title 13 for RED and BLUE (Does not apply to all flash patterns)

## ENTORNO INDUSTRIAL, S.A. DE C.V.

Juan Sarabia No. 205. Col. Nueva Santa María. 02800 México, D.F.  
Tels.: (55) 5356-7206 • Fax: (55) 5356-7209  
e-mail: ventas@entorno-industrial.com • direccion@entorno-industrial.com

www.entorno-industrial.com



# TRAFFIC DIRECTORS

## STAR PHANTOM® - UNDERCOVER LED TRAFFIC DIRECTOR

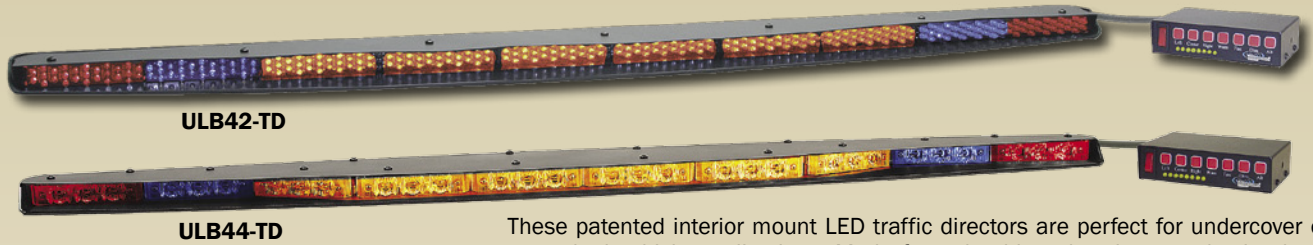

These patented interior mount LED traffic directors are perfect for undercover or unmarked vehicle applications. Made from durable polycarbonate plastic, these traffic directors will not warp or bend. With an extremely thin profile, less than 1" high, they easily mount in the rear window. The ULB42-TD offers 270 Star Generation-1 LEDs while the ULB44-TD offers 30 high intensity Star Generation-4 LEDs. The microprocessor control unit with tactile switching gives you four distinctive pattern modes with three NEW "option" buttons (Fast, Dim, and Alt). Four outboard LED sections (two at each end) allow different color combinations for warning patterns while using the six inner Amber LED sections for traffic directing. They ship complete with control unit, attached wire harness, mounting brackets, hardware, and instructions.

### Models & Specifications:

<b>Size:</b>	<b>ULB42-TD-2 Control Unit:</b>	1-1/2"H x 6"W x 4-1/2"D
	<b>ULB42-TD-1 Traffic Director:</b>	15/16"H x 42"W x 4-3/4"D
	<b>ULB44-TD-1 Traffic Director:</b>	15/16"H x 42"W x 4-3/4"D

<b>Weight:</b>	2.6 lbs.
<b>Voltage:</b>	12V DC
<b>Cable Length:</b>	15', 30', 45', or 60'
<b>Modes:</b>	Left Arrow, Right Arrow, Center Out, and Warn (Alternating)

**Color Combinations for outboard LED flasher sections:**  
Amber/Amber, Blue/Blue, Red/Red, Red/Blue

PARTS	PART#
Control Unit.....	ULB42-TD-2
Mounting Bracket Kit.....	ULB-BKT
Bulk Cable (per foot).....	TD92-3

## TCS SERIES - TRAFFIC SAFETY SIGNS



### STOP/SLOW

The TCS series traffic control signs put traffic safety control right at your fingertips. Micro-processor controlled, the ultra bright flashing LED light sequences bring attention quickly to any situation. The automatic activation control means you can provide quick response to any need. When the sign is lifted upright, it turns ON. When the sign is lowered down, it shuts OFF. Operates on 3 "C" cells (not included).

### Models & Specifications:

<b>TCS-2:</b>	Stop/Stop Traffic Control Sign (104 LEDs)
<b>TCS-2REF:</b>	Stop/Stop Traffic Control Sign w/M.U.T.C.D. approved reflective tape (104 LEDs)

<b>TCS-1:</b>	Slow/Stop Traffic Control Sign (113 LEDs)
<b>TCS-1REF:</b>	Slow/Stop Traffic Control Sign w/M.U.T.C.D. approved reflective tape (113 LEDs)

<b>Size:</b>	18" Octagon with 6" Letters
<b>Weight:</b>	2 lbs.

<b>Also Available:</b>	
<b>TCS-6:</b>	6' Extension Pole (not shown)

<b>Approvals:</b>	TCS-1REF, TCS-2REF M.U.T.C.D. Code (Manual on Uniform Traffic Control Devices)
-------------------	---

## ENTORNO INDUSTRIAL, S.A. DE C.V.

Juan Sarabia No. 205. Col. Nueva Santa María. 02800 México, D.F.  
Tels.: (55) 5356-7206 • Fax: (55) 5356-7209  
e-mail: ventas@entorno-industrial.com • direccion@entorno-industrial.com

www.entorno-industrial.com





## ULB42 - STAR PHANTOM® UNDERCOVER LED LIGHTBAR



ULB42 Star Phantom®



ULB42-DLP Star Phantom®  
w/Directional LED Pursuit Mode

The patented STAR Phantom® interior mount LED lightbar is perfect for undercover or unmarked vehicle applications. With an extremely thin profile, less than 1" high, the ULB42 series easily mounts under the center visor clips above the rear view mirror in 15-20 minutes. The ULB42 offers 270 Star Generation-1 LEDs while the ULB42-DLP offers 216 Star Generation LEDs & 6 high intensity Star Generation-4 LEDs. Both STAR Phantom® series lightbars offer 35 customer selectable flash patterns via a push button switch and a 30 second Superburst™ all LED steady burn. The ULB42-DLP also offers a Directional LED Pursuit mode. Two angled LED sections offer intersection clearing and a red "night vision" preserving map light are standard. An adjustable baffle is also included to eliminate "flash back" from the window. A rear window mount version is available with a standard 12' wire harness only for the ULB42 (ULB42-1). The ULB42 series ships complete with cig plug with lighted on/off switch, mounting brackets, hardware, and instructions.

### Specifications:

<b>Size:</b>	15/16"H x 42"W x 4-3/4"D	
<b>Weight:</b>	2.6 lbs.	
<b>Voltage:</b>	12V DC	
<b>Amp Draw*:</b>	ULB42:	2.36 Amps (Average), 5.4 Amps (max)
	ULB42-DLP:	3.0 Amps (Average), 6.0 Amps (max)
<b>Color Combo:</b>	Amber, Blue, Green, Red, White	
<b>Approvals:</b>	California Title 13, SAE J595 (available) (Does not apply to all flash patterns)	

\*Amp draw varies depending on color of LED used and the flash pattern selected.

PARTS - ULB42 SERIES		PART#
Cig Plug.....		920-10
Flasher Circuit.....		ULB399
Mounting Bracket Kit for Front/Rear.....		ULB-BKT
Baffle .....		30147-89P

## ULB21 - STAR SPLIT-PHANTOM™ & ULB10 HALF-PHANTOM™



ULB21 SPLIT-PHANTOM™



ULB10 HALF-PHANTOM™

The STAR Split-Phantom™ and STAR Half-Phantom™ interior mount LED lightbars are perfect for undercover or unmarked vehicle applications. With an extremely thin profile, less than 1" high, the ULB21 and ULB10 are specifically designed to mount in the front windshield visor area. The ULB21 straddles the overhead console while the ULB10 mounts on the passenger side. Mounting time for both is less than 15-20 minutes. No drilling required with specific visor brackets. The ULB21 with 216 long-life LEDs or the ULB10 with 108 long-life LEDs will give you the power and flexibility you need. They both offer 35 customer selectable flash patterns with the push of a button, angled LED sections for intersection clearing, and a 30 second Superburst™ all LED steady burn. Adjustable baffles are included to eliminate "flash back" from the window. The ULB21 and ULB10 ship complete with cig plug with lighted on/off switch, mounting brackets, hardware, and instructions.

### Specifications:

<b>Size:</b>	<b>ULB21:</b>	15/16"H x 34"min. - 42"max.W x 6"D
	<b>ULB10:</b>	15/16"H x 16-3/4"W x 6"D
<b>Weight:</b>	<b>ULB21:</b>	2.8 lbs.
	<b>ULB10:</b>	2.5 lbs.
<b>Voltage:</b>	12V DC	
<b>Amp Draw*:</b>	<b>ULB21:</b>	2.4 Amps (average), 4.7 Amps (max)
	<b>ULB10:</b>	1.2 Amps (average), 2.4 Amps (max)
<b>Color Combo:</b>	Amber, Blue, Green, Red, White	
<b>Approvals:</b>	California Title 13, SAE J595 (available) (Does not apply to all flash patterns)	

\*Amp draw varies depending on color of LED used and the flash pattern selected.

PARTS-ULB21.....		PART#
Cig Plug .....		920-10
Baffle (ULB21 requires two per light).....		30147-151P
Vehicle Specific Mounting Bracket Kits:		
Chevy Impala.....		274-ULB21-IM
Chevy Tahoe .....		274-ULB21-TA
Dodge Charger .....		274-ULB21-CH
Dodge Charger '11-'12 .....		274-ULB21-CH11
Ford Crown Victoria .....		274-ULB21-CV
Ford Explorer.....		274-ULB21-EX
Universal Mount .....		274-ULB21-UI
Chevy Caprice .....		274-ULB21-CP
PARTS-ULB10.....		PART#
Cig Plug w/Lighted On/Off Switch .....		920-10SW
Baffle (ULB21 requires two per light).....		30147-151P
Vehicle Specific Mounting Bracket Kits:		
Chevy Impala.....		274-ULB10-IM
Chevy Tahoe .....		274-ULB10-TA
Dodge Charger .....		274-ULB10-CH
Dodge Charger '11-'12 .....		274-ULB21-CH11
Ford Crown Victoria .....		274-ULB10-CV
Ford Explorer.....		274-ULB10-EX
Universal Mount .....		274-ULB10-UI
Chevy Caprice .....		274-ULB10-CP



# STARBURST PHANTOM<sup>®</sup>

## ULB44 - STARBURST PHANTOM<sup>®</sup> LED LIGHTBAR



**ULB44 StarBurst Phantom<sup>™</sup>**  
 or  
**ULB44-DLP StarBurst Phantom**  
**w/Directional LED Pursuit Mode**

The NEW High-Intensity StarBurst Phantom<sup>™</sup> interior mount lightbar is perfect for undercover or unmarked vehicle applications. With an extremely thin profile, less than 1" high, the ULB44 series easily mounts under the center visor clips above the rear view mirror in 15-20 minutes. The ULB44 and ULB44-DLP utilize 30 long-life, STAR Generation-4 LEDs. Both models offer a red "night vision" preserving map light, two angled LED sections for intersection clearing, an adjustable baffle to eliminate "flash back" from the window. The StarBurst Phantom<sup>™</sup> series lightbars offer 35 customer selectable flash patterns via a push button switch and a 30 second Superburst<sup>™</sup> all LED steady burn. The ULB44-DLP also offers a Directional LED Pursuit mode. A rear window mount version is available with a standard 12' wire harness only for the ULB44 (ULB44-1). Ships complete with mounting brackets, hardware, and instructions.

### Specifications:

**Size:** 15/16"H x 42"W x 4-3/4"D  
**Weight:** 3 lbs.  
**Voltage:** 12V DC  
**Amp Draw\*:** 3.1 amps (average), 6.25 amps (max)  
**Color Combo:** Amber, Blue, Green, Red, White  
**Approvals:** California Title 13, SAE J595 (available)  
 (Does not apply to all flash patterns)

\*Amp draw varies depending on color of LED used and the flash pattern selected.

### PARTS - ULB44 SERIES

Cig Plug.....	920-10	<b>PART#</b>
Mounting Bracket Kit for Front/Rear.....	274-ULB42BKT	
Baffle.....	30147-89P	

## ULB24 - STARBURST HALF-PHANTOM<sup>™</sup> & ULB14 STARBURST SPLIT-PHANTOM<sup>™</sup>

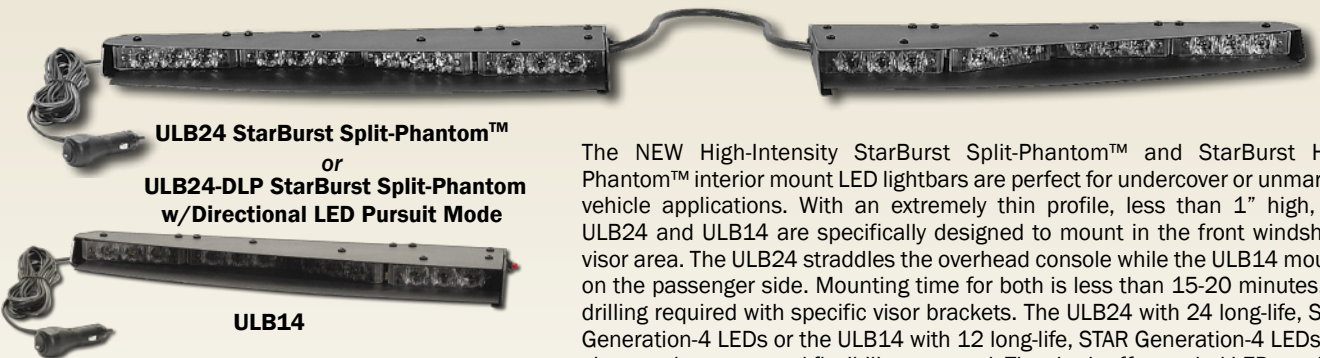

**ULB24 StarBurst Split-Phantom<sup>™</sup>**  
 or  
**ULB24-DLP StarBurst Split-Phantom**  
**w/Directional LED Pursuit Mode**

**ULB14**

The NEW High-Intensity StarBurst Split-Phantom<sup>™</sup> and StarBurst Half-Phantom<sup>™</sup> interior mount LED lightbars are perfect for undercover or unmarked vehicle applications. With an extremely thin profile, less than 1" high, the ULB24 and ULB14 are specifically designed to mount in the front windshield visor area. The ULB24 straddles the overhead console while the ULB14 mounts on the passenger side. Mounting time for both is less than 15-20 minutes. No drilling required with specific visor brackets. The ULB24 with 24 long-life, STAR Generation-4 LEDs or the ULB14 with 12 long-life, STAR Generation-4 LEDs will give you the power and flexibility you need. They both offer angled LED sections for intersection clearing, an adjustable baffle to eliminate "flash back" from the window. Both series lightbars offer 35 customer selectable flash patterns via a push button switch and a 30 second Superburst<sup>™</sup> all LED steady burn. The ULB24-DLP also offers a Directional LED Pursuit mode. Ships complete with mounting brackets, hardware, and instructions.

### Specifications:

**Size:** ULB24: 15/16"H x 34" min. - 42"max"W x 6"D  
 ULB14: 15/16"H x 16-3/4"W x 6"D  
**Weight:** ULB24: 2.8 lbs.  
 ULB14: 1.5 lbs.  
**Voltage:** 12V DC  
**Amp Draw\*:** ULB24: 2.5 amps (average), 5.0 amps (max)  
 ULB14: 1.3 amps (average), 2.5 amps (max)  
**Color Combo:** Amber, Blue, Green, Red, White  
**Approvals:** California Title 13, SAE J595 (available)  
 (Does not apply to all flash patterns)

\*Amp draw varies depending on color of LED used and the flash pattern selected.

### PARTS-ULB21

Cig Plug .....	920-10	<b>PART#</b>
Baffle (ULB21 requires two per light).....	30147-151P	
Vehicle Specific Mounting Bracket Kits:		
Chevy Impala.....	274-ULB21-IM	
Chevy Tahoe .....	274-ULB21-TA	
Dodge Charger .....	274-ULB21-CH	
Dodge Charger '11-'12 .....	274-ULB21-CH11	
Ford Crown Victoria .....	274-ULB21-CV	
Ford Explorer .....	274-ULB21-EX	
Universal Mount .....	274-ULB21-UI	
Chevy Caprice .....	274-ULB21-CP	

### PARTS-ULB10

Cig Plug w/Lighted On/Off Switch .....	920-10SW	<b>PART#</b>
Baffle (ULB21 requires two per light).....	30147-151P	
Vehicle Specific Mounting Bracket Kits:		
Chevy Impala.....	274-ULB10-IM	
Chevy Tahoe .....	274-ULB10-TA	
Dodge Charger .....	274-ULB10-CH	
Dodge Charger '11-'12 .....	274-ULB10-CH11	
Ford Crown Victoria .....	274-ULB10-CV	
Ford Explorer.....	274-ULB10-EX	
Universal Mount .....	274-ULB10-UI	
Chevy Caprice .....	274-ULB10-CP	
Universal Mount .....	274-ULB10-UI	

## ENTORNO INDUSTRIAL, S.A. DE C.V.

Juan Sarabia No. 205. Col. Nueva Santa María. 02800 México, D.F.  
 Tels.: (55) 5356-7206 • Fax: (55) 5356-7209  
 e-mail: ventas@entorno-industrial.com • direccion@entorno-industrial.com

www.entorno-industrial.com



# STARVISOR II™ - VL22 SERIES - LED VISOR LIGHT



VL22

The STARVISOR II™ series high-intensity LED lights give you plenty of possibilities to customize to your individual needs. The STARVISOR II™ VL22 series offers 30 different customer selectable flash patterns along with Auto-Tilt™ Automatic Activation. It automatically switches on when visor is pulled down and automatically switches off when visor is lifted up (Auto-Tilt™ feature can be disabled). High impact resistant polycarbonate plastic housing, vibration resistant LED technology, and micro-controlled solid state flasher allows for long life. Power indication LED allows you to see ready status. Auto-voltage adjust compensates for varying vehicle voltage (10V - 16V DC). Designed to be visor mount only. Ships complete with cig plug, hook and loop fasteners, and instructions.

### Specifications:

<b>Size:</b>	4"H x 11-1/2"W x 7/8"D
<b>Weight:</b>	Less than 1 lb.
<b>Voltage:</b>	10V - 16V DC
<b>Amp Draw*:</b>	1.5 Amps
<b>Colors Available:</b>	Red/Blue, Blue/Blue, Red/Red, Amber/Red Amber/Blue, Amber/Amber, Red/White, Amber/White, Amber/Green, White/White

\*Amp draw will vary depending on the color of the LED heads used and the flash pattern selected.

### PARTS

	Part #
Cig Plug.....	176
Clear Lens.....	30129-10C
Hook & Loop Strap.....	30209-1
Back Plate.....	30019-59
Back Plate Screw.....	30052-32
Switch Button Nut.....	30007-81-1
Front Housing/Frame.....	30214-2



## STAR LED MINI-BAR™

NEW  
M-Tech Plus™ LED  
Technology

## 9016LED SERIES STARBEAM™ M-TECH PLUS® LED



9016LEDV



9016LED

The 9016LED Series are low profile Mini-Bars designed with NEW M-Tech Plus® LED technology that provides a superior 360° warning light image. Conformal coated circuitry protects against shock and vibration while the durable polycarbonate domes are fully gasketed between the rugged one piece, extruded, anodized base to protect against moisture. Ships complete with permanent mounting hardware, and instructions. Magnetic mounts include vinyl pads to avoid scratching surfaces.

### Models:

<b>9016LED:</b>	Permanent mount 20 Customer selectable flash patterns via external pattern select wire or internal jumper, S-LINK SYSTEM™ is standard offering synchronizing capability with other STAR LED units, 24" wire leads
<b>9016LEDM:</b>	Standard Magnetic mount
<b>9016LEDV:</b>	Vacuum Magnetic mount 20 Customer selectable flash patterns via internal jumper 12' cigarette plug adapter with lighted on/off switch

### Specifications:

<b>Dimensions:</b>	3-3/4"H x 16"L x 8-3/8"D
<b>Voltage:</b>	12V - 24V DC
<b>Amp Draw:</b>	Amber or Red: 2 Amps (max) Blue, White, Green or Blue/White: 3.6 Amps (max) Amber/White, or Amber/Green, Red/Blue: 2.8 Amps (max)
<b>LED Color Combo:</b>	Amber, Amber/White, Amber/Green, Red, Red/Blue, Blue, Blue/White, Green, White (Blue, Green, or White LEDs available only with Clear Dome)
<b>Dome Colors:</b>	Amber, Clear, Red
<b>Approvals:</b>	SAE Class I (Amber, Blue, Red) SAE Class II (Clear, Green) (Does not apply to all flash patterns)

## ENTORNO INDUSTRIAL, S.A. DE C.V.

Juan Sarabia No. 205. Col. Nueva Santa Maria. 02800 México, D.F.  
Tels.: (55) 5356-7204 • Fax: (55) 5356-7209  
e-mail: ventas@entorno-industrial.com • direccion@entorno-industrial.com

www.entorno-industrial.com





Our new Star Contour™ is made to “contour-fit” to the roof of your vehicle. The injection-molded polycarbonate base combines with a rubber-coated vacuum magnet to “custom” mount on to your vehicle. The result is a perfect fit with no scratches to your paint.

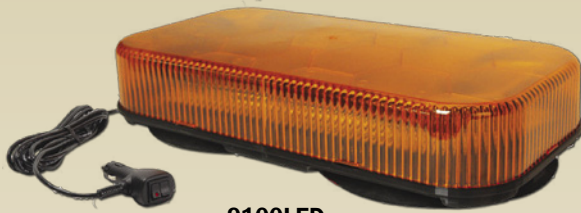

9100LED

### Specifications:

- Extremely low profile!
- Full 360° LED light output
- Super bright M-Tech® LED technology provides superior warning light image
- Durable polycarbonate, injection molded domes are fully gasketed to protect against moisture
- Conformal coated circuitry protects against shock and vibration
- Permanent Mount:
  - 20 Customer selectable flash patterns via external pattern select wire
  - S-Link System™ synchronizing capability with other Star LED units
  - 24" wire leads
- Vacuum Magnetic Mount:
  - 20 Customer selectable flash patterns
  - 12' cigarette plug adapter with lighted on/off and pattern select switches
- Dome Colors: Amber, Clear, Red, Blue and Green
- Amp Draw: 2.3 (max)
- Dimensions: 3" H x 16-1/2" L x 8-3/8" D
- Voltage: 12V – 24V DC
- Approvals: SAE J845 Class I (Amber, White and Blue)

### Models:

- 9100LED: Contour™ M-Tech® LED Mini-Bar, permanent mount
- 9100LEDM: Contour™ M-Tech® LED Mini-Bar, magnetic mount
- 9100LEDV: Contour™ M-Tech® LED Mini-Bar, vacuum magnetic mount



## 9200H8L & 9200HL SERIES STAR HALO® LED

STAR Halo® LED technology is a patent pending, extremely low current draw, ultra high intensity LED light that exceeds the latest J845 and CA13 standards. The circuitry is designed with 12 customer selectable flash patterns, high/low intensity feature (Manual or Automatic), and S-Link System™ that allows synchronizing capabilities with other STAR LED products. Circuitry is fully encapsulated for increased weather and shock resistance. Fully gasketed between the durable polycarbonate dome and base. Two internal V-mirrors enhance flashes. Magnetic mounts include vinyl pads to avoid scratching surfaces.

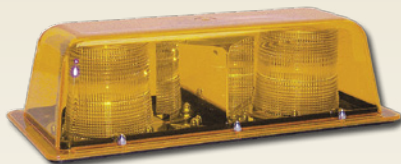

9200HL Series



9200HLM Series



Cig Plug includes Pattern Select and On/Off Switches



9200HLV Series

### Models:

- 9200H8L: SAE Class I, California Title 13, Ultra High Intensity STAR Halo® LEDs Optics
- 9200H8LM: SAE Class I, California Title 13, Ultra High Intensity STAR Halo® LEDs Optics
- 9200H8LV: SAE Class I, California Title 13, Ultra High Intensity STAR Halo® LEDs Optics
- 9200HL: SAE Class I, High Intensity STAR Halo® LEDs Optics
- 9200HLM: SAE Class I, High Intensity STAR Halo® LEDs Optics
- 9200HLV: SAE Class I, High Intensity STAR Halo® LEDs Optics

### Specifications:

- Dimensions: 4-1/2" H x 16-1/8" W x 7-1/4" D (less magnets)
- Voltage: Permanent mount: 12V – 24V DC, Magnetic mount: 12V DC only
- Amp Draw: 1.2 Amps @ 12V DC, 0.6 Amps @ 24V DC
- Dome Colors: Amber, Blue, Clear, Green, Red, Magenta
- Approvals: SAE Class I, California Title 13 (Amber)  
(Does not apply to all flash patterns)

#### Permanent mount

12 Customer selectable flash patterns via external pattern select wire, S-LINK SYSTEM™ synchronizing capability with other STAR LED units, 24" wire leads

#### Standard Magnetic mount

12 Customer selectable flash patterns, Cigarette plug with On/Off Switch and Pattern Select Switch

#### Vacuum Magnetic mount

12 Customer selectable flash patterns, Cigarette plug with On/Off Switch and Pattern Select Switch

# STAR MINI-BAR®

## STAR MINI-BARS®



9200H

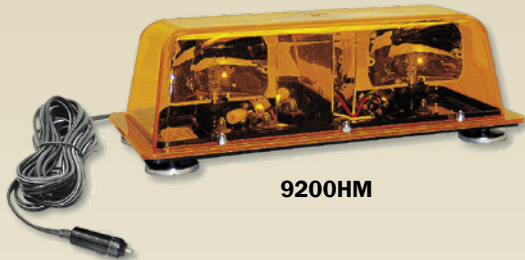

9200HM

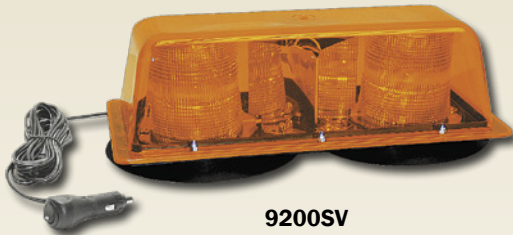

9200SV

### STAR MINI-BARS®

The Mini-Bar® Series offers a compact, all-in-one package with the reliability and attention getting power you need. Patented shock mounted rotators with two sealed roller bearings provide quiet, smooth, and maintenance free operation, and are available in standard speed (80fpm) or high speed (160fpm). Dual rotators are enhanced with a single wall mirror. While the dual high intensity strobes are enhanced with twin internal V-mirrors. The circuit and strobe tube assemblies are fully encapsulated to guard against shock and vibration and are also easily field replaceable. Durable polycarbonate domes resist UV deterioration and are fully gasketed to protect against elements. The polycarbonate plastic bases make these Star Mini-Bars® lightweight and will not corrode. The Mini-Bars® are offered in both permanent and magnetic mount. Super powerful, rubber coated, 8" vacuum magnets are also available. Ship complete with mounting hardware and instructions. Magnetic mount versions ship with attached cig plug and vinyl pads for magnets to avoid scratching.

### Models:

- 9200H:** Star Mini-Bar® with two rotators, one wall mirror, two 50 watt halogen bulbs
- 9200HM:** Star Mini-Bar® with two rotators, one wall mirror, two 50 watt halogen bulbs, magnetic mount and cig plug
- 9200HV:** Star Mini-Bar® with two rotators, one wall mirror, two 50 watt halogen bulbs, vacuum magnet mount and cig plug
- 9200I:** Star Mini-Bar® with two rotators, one wall mirror, two 35 watt incandescent bulbs
- 9200IM:** Star Mini-Bar® with two rotators, one wall mirror, two 35 watt incandescent bulbs, magnetic mount and cig plug
- 9200IV:** Star Mini-Bar® with two rotators, one wall mirror, two 35 watt incandescent bulbs, vacuum magnet mount and cig plug
- 9200S:** Double/Quad Flash Mini-Bar® with two 360° remote strobe heads, one double v-mirror, one 2-head strobe pack
- 9200SM:** Double/Quad Flash Mini-Bar® with two 360° remote strobe heads, one double v-mirror, one 2-head strobe pack, magnet mount and cig plug with on/off switch
- 9200SV:** Double/Quad Flash Mini-Bar® with two 360° remote strobe heads, one double v-mirror, one 2-head strobe pack, vacuum magnet mount and cig plug with on/off switch

### Specifications:

- Size:** 4-1/2"H x 16-1/8"W x 7-1/4"D
- Weight:** Less than 5 lbs.
- Voltage:** Halogen: 12V DC (24V DC available)  
Incandescent: 12V DC  
Strobe: 12V 24V DC
- Amp Draw:** Halogen: 8 Amps @ 12V DC  
Incandescent: 5.6 Amps @ 12V DC  
Strobe: 2 Amps @ 12V DC
- Flash Rate:** Standard: 80fpm (+/-10) per rotator  
High Speed: 160fpm (+/-10) per rotator
- Color:** Outer Dome & Filters:  
Amber, Blue, Clear, Green, Red, Magenta
- Approvals:** Halogen: SAE J845, Class 1 (Amber, Blue, Clear, Red)  
Double Flash: SAE J1318, Class II Amber

Parts- Mini-Bar®	PART#
Outer Dome.....	920-3
Color Filter for Rotator.....	920-100
Inner Fresnel lens.....	333
Bulb	
Halogen.....	2073-795
Incandescent .....	2073-1195
Strobe tube.....	ST3901-7
Standard Rotator Assembly with Motor.....	920-0
High Speed Rotator Assembly with Motor.....	920-0F
Rotator Motor .....	920-5
Wall Mirror.....	920-30-3
Cig Plug.....	920-10
Cig Plug w/lighted on/off Switch.....	920-10SW
Double/Quad Flash Power Supply.....	620-181-SBP
Magnet * (one).....	920-16
Mag Mount Kit* (four).....	920-16-4K
Vacuum Magnet (one).....	920-16V

\* Available with magnetic mount models only.

## ENTORNO INDUSTRIAL, S.A. DE C.V.

Juan Sarabia No. 205. Col. Nueva Santa María. 02800 México, D.F.  
Tels.: (55) 5356-7206 • Fax: (55) 5356-7209  
e-mail: ventas@entorno-industrial.com • direccion@entorno-industrial.com

www.entorno-industrial.com





9216H



9216S

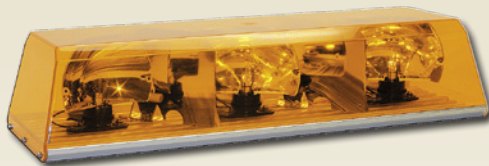

9224H



9224S

### STROBE & HALOGEN

The STARBEAM™ 9216 & 9224 Series Star Mini-Bars® offer a heavy duty, all-in-one package with the reliability and attention getting power you need. Choose from high intensity strobes or patented shock mounted rotators with two sealed roller bearings providing quiet, smooth, and maintenance-free operation. The circuits and strobe tube assemblies in the strobe models are fully encapsulated to guard against shock and vibration, while the rotator models offer lock-and-stay bulbs that are field replaceable. Wall mirrors are standard for both models. Durable polycarbonate domes resist UV deterioration and are fully gasketed to protect against the elements. The rugged aluminum extruded base will not bend or warp. The STARBEAM™ 9216 & 9224 Series are available in permanent, T-Slot mounting. The STARBEAM™ 9216 is also available in magnetic mount with cig plug adapter. Ships complete with 15' lead, mounting hardware and instructions. Magnetic mount versions ship with attached cig plug with lighted On/Off switch and vinyl pads for magnets to avoid scratching.

### Models:

- 9216H:** 16" Star Mini-Bar® with two rotators, one wall mirror, two 58 watt halogen bulbs
- 9216HM:** 16" Star Mini-Bar® with two rotators, one wall mirror, two 58 watt halogen bulbs, magnetic mount with cig plug adapter
- 9216S:** 16" Star Mini-Bar® with two 360° Quad Flash strobes, one wall mirror
- 9216SM:** 16" Star Mini-Bar® with two 360° Quad Flash strobes, one wall mirror, magnetic mount with cig plug adapter
- 9224H:** 24" Star Mini-Bar® with three rotators, two wall mirrors, three 58 watt halogen bulbs
- 9224S:** 24" Star Mini-Bar® with three 360° Quad Flash strobes, two wall mirrors

### Specifications:

- Size:** **9216:** 5-1/2"H x 16"W x 8-1/2"D  
**9224:** 5-1/2"H x 24"W x 8-1/2"D
- Weight:** **9216:** 8 lbs.  
**9224:** 10 lbs.
- Voltage:** **Halogen:** 12V DC  
**Strobe:** 12V - 24V DC
- Amp Draw:** **Halogen:** 4.75 Amps per rotator  
**Strobe:** 2 Amps per strobe head
- Joules:** **Strobe:** 17.3 joules per strobe head
- Flash Rate:** **Strobe:** 75 Quad Flash sequences per minute, per self-contained strobe @ 24 Watts  
**Rotator:** 120fpm (+/-10) per rotator
- Color:** **Outer Dome & Inner Lens:** Amber, Blue, Clear, Red
- Approvals:** **9216H:** SAE J845, Class 1  
(Amber, Clear)
- Approvals:** **9216H:** SAE J845, Class 1 - Amber, Clear  
California Title 13 - Amber

### PARTS - 9216 & 9224

	Part#
Flash Tube .....	129
Quadflash Circuit .....	181-Q4-12
58 Watt Halogen Bulb.....	2073-795X58
4" Quadflash Strobe.....	240SFQ1
4" Fresnel Lens .....	297-
Wall Mirror.....	920-30-2
Outer Dome (9216 Series).....	920-316
Outer Dome (9224 Series).....	920-324
Rotator Assembly (Less Bulb).....	920-99-2
Motor (120fpm) .....	920-18F
Mounting Pad Gasket 16" .....	920-17-16
Mounting Pad Gasket 24" .....	920-17-24
Mag Mount Kit (9216HM, 9216SM) .....	910-177K
Cig Plug (9216HM, 9216SM) .....	920-10SW

## ENTORNO INDUSTRIAL, S.A. DE C.V.

Juan Sarabia No. 205. Col. Nueva Santa María. 02800 México, D.F.  
Tels.: (55) 5356-7206 • Fax: (55) 5356-7209  
e-mail: ventas@entorno-industrial.com • direccion@entorno-industrial.com

www.entorno-industrial.com







7400 Series 46" Star Laser® Lightbar

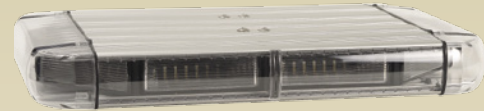

7200 Series 22" Star Laser® Lightbar

### Innovative Sculptured Design

The STAR LASER® is the newest generation of low-profile lightbars. A blend of innovative modular design, sculptured contours, exceptional strength and durability. Laser Cage Technology™ is the most advanced, integrated componentry design. STAR LASER® LCT provides the ability for each modular head to be interchangeable with other modular heads for multiple custom configurations. "ISO-VIBE" modular head design provides circuitry protection and is equipped with plug-n-play electronic connections for smooth adaptation to your needs. Rugged exterior, extruded aluminum bases and UV stabilized polycarbonate lenses provide a lean, more assertive stance to any vehicle form. STAR LASER® provides fail safe operation by utilizing independent driver circuits for each head that allows for synchronization of heads in simultaneous or alternating mode and flash pattern control.

### Additional Options & Specifications:

- LED module colors: Amber, Blue, Green, Red, White
- End position can also be color warning light
- Standard mounting kit included
- Vehicle specific mounting straps available
- Front lenses standard clear, Also available in Amber, Blue, Red
- End caps standard clear, Also available in Amber, Blue, Red with optional clear alley light window

### AVAILABLE IN FIVE LENGTHS

- 7200 Series 22 in.
- 7300 Series 34 in.
- 7400 Series 46 in.
- 7500 Series 52 in.
- 7600 Series 58 in.

All only 2-5/8 in. tall  
12-1/4 in. wide for maximum visibility

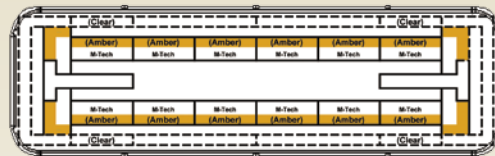

For your Custom Star Laser® Lightbar Design Configurator,

please contact STAR at 585-226-9500 or [www.starheadlight.com](http://www.starheadlight.com)

### Exterior Construction

- Rugged top and bottom aluminum extrusions
- Optical grade UV stabilized virgin polycarbonate lenses
- Weatherproof seals and stainless steel fasteners
- Streamlined design

### Serviceability

- Top extrusion removes completely for access to modular components
- Front lenses stay securely in place

## LASER MODULES

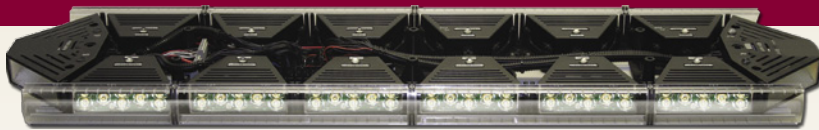

### High Density™ LED head

- 12 or 18 version available
- Gen 4 LEDs
- Full programmability
- High LED count for bid spec. Requirements
- High efficiency linear optics
- Wide angle light distribution
- Achieves SAE Class I rating without use of flashing alley light



### STAR BURST™

- (8) Gen 4 LEDs
- Patent Pending optical system
- Narrow light distribution
- Compatible with end or front facing heads
- SAE Class I
- Traffic director stop/turns available
- Can be programmed for TDP



### M-tech®

- (6) Gen 4 LEDs
- M-tech optical system
- Wide angle light distribution
- Compatible with end or front facing heads
- SAE Class I
- Full programmability



### Discrete™

- Gen 1 LEDs
- Large image
- Primarily used for traffic directors
- Multiple color traffic directors



## ENTORNO INDUSTRIAL, S.A. DE C.V.

Juan Sarabia No. 205. Col. Nueva Santa María. 02800 México, D.F.  
Tels.: (55) 5356-7206 • Fax: (55) 5356-7209  
e-mail: [ventas@entorno-industrial.com](mailto:ventas@entorno-industrial.com) • [direccion@entorno-industrial.com](mailto:direccion@entorno-industrial.com)

[www.entorno-industrial.com](http://www.entorno-industrial.com)





# STAR RAZOR® LIGHTBARS



## STAR RAZOR® LIGHTBARS - 36" EMERGENCY PACKAGES



Only 2-3/4" Tall!

2364LED

Lenses and filters are available in red, blue, amber, green, and clear. A BLACK plastic, low profile, direct roof mount kit is standard and included (820-39-PB). A traffic director control unit is included with lightbars containing a traffic director assembly.

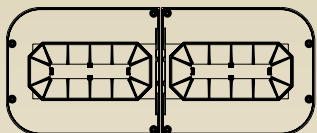

**Standard Models:**

#2364LED M-Tech Plus® LED lightbar with 64 LEDs

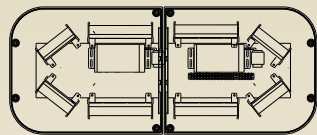

#2300SL Four 7" linear strobe heads, four 4.5" linear strobe heads, two 4-head strobe packs

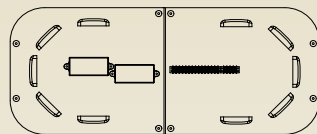

#2378-\*\* Ten Versa Star® DLX6 LEDs



## STAR RAZOR® LIGHTBARS - 46" EMERGENCY PACKAGES



2464LED

**Standard Models:**

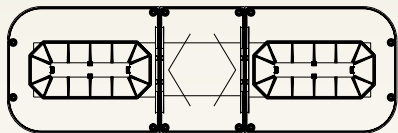

#2464LED M-Tech Plus® LED lightbar with 64 LEDs, two V-mirrors

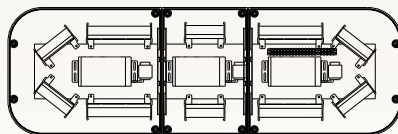

#2400SL Four 7" linear strobe heads, six 4.5" linear strobe heads, two 4-head strobe packs, and one 2-head strobe pack

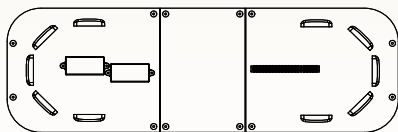

#2478-\*\* Ten Versa Star® DLX6 LEDs

To view all STAR RAZOR® LIGHTBARS or request a custom lightbar design kit, please contact us at [www.starheadlight.com](http://www.starheadlight.com)  
SAE Class 1 & California Title 13 approved when properly configured

**ENTORNO INDUSTRIAL, S.A. DE C.V.**

Juan Sarabia No. 205. Col. Nueva Santa María. 02800 México, D.F.  
Tels.: (55) 5356-7206 • Fax: (55) 5356-7209  
e-mail: [ventas@entorno-industrial.com](mailto:ventas@entorno-industrial.com) • [direccion@entorno-industrial.com](mailto:direccion@entorno-industrial.com) [www.entorno-industrial.com](http://www.entorno-industrial.com)





# STAR RAZOR® LIGHTBARS



## STAR RAZOR® LIGHTBARS - 46" EMERGENCY PACKAGES



2464LED-TOW

Lenses and filters are available in red, blue, amber, green, and clear. A BLACK plastic, low profile, direct roof mount kit is standard and included (820-39-PB). A traffic director control unit is included with lightbars containing a traffic director assembly.

### Standard Models:

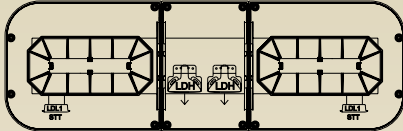

**#2464LED-TOW** M-Tech Plus® LED lightbar with 64 LEDs, two rear halogen worklights, two LED stop/tail/turn lights

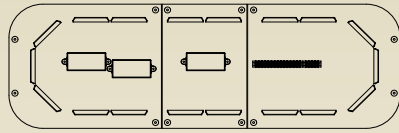

**#2486-\*\*** Fourteen Batwing Versa Star® DLX6 LEDs, two takedown/pursuit LED lights, two LED alley lights

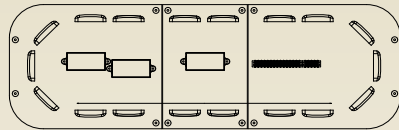

**#2472-\*\*** Eight Versa Star® DLX6 LEDs, two takedown/pursuit LED lights, two LED alley lights, six head traffic director



## STAR RAZOR® LIGHTBARS - 56" EMERGENCY PACKAGES



2564LED-TOW

### Standard Models:

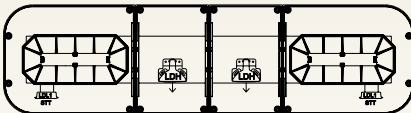

**#2564LED-TOW** M-Tech Plus® LED lightbar with 64 LEDs, two rear halogen worklights, two LED stop/tail/turn lights

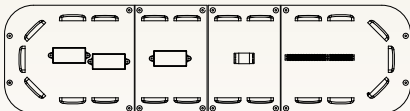

**#2576LED-TOW** Sixteen Versa Star® DLX6 LEDs, four LED worklights to the rear, two red LED STT lights

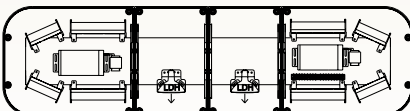

**#2510SL** Four 7" linear strobe heads, four 4.5" linear strobe heads, two 4-head strobe packs, two rear work lights

To view all STAR RAZOR® LIGHTBARS or request a custom lightbar design kit, please contact us at [www.starheadlight.com](http://www.starheadlight.com)  
SAE Class 1 & California Title 13 approved when properly configured

### ENTORNO INDUSTRIAL, S.A. DE C.V.

Juan Sarabia No. 205. Col. Nueva Santa Maria. 02800 México, D.F.  
Tels.: (55) 5256-7206 • Fax: (55) 5256-7209  
e-mail: [ventas@entorno-industrial.com](mailto:ventas@entorno-industrial.com) • [direccion@entorno-industrial.com](mailto:direccion@entorno-industrial.com) • [www.entorno-industrial.com](http://www.entorno-industrial.com)







# STAR SABRE® LIGHTBARS

NEW  
M-Tech Plus™ LED  
Technology

## STAR SABRE® LIGHTBARS - 36" EMERGENCY PACKAGES



The only dual level, full output lightbar less than 4" tall!

**5364LED**

Lenses and filters are available in red, blue, amber, green, and clear. A BLACK plastic, low profile, direct roof mount kit is standard and included (820-39-PB). A traffic director control unit is included with lightbars containing a traffic director assembly.

### Standard Models:

- #5364LED M-Tech Plus® LED lightbar with 64 LEDs
- #5300H Two halogen rotators, two fast halogen rotators, two Z-mirrors
- #5300S Two 360° remote strobe heads, one 2-head strobe pack, two large V-mirrors

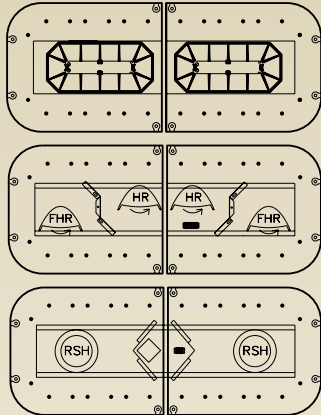

NEW  
M-Tech Plus™ LED  
Technology

## STAR SABRE® LIGHTBARS - 46" EMERGENCY PACKAGES



**5464LED**

### Standard Models:

- #5464LED M-Tech Plus® LED lightbar with 64 LEDs, two v-mirrors
- #5400H Two halogen rotators, two fast halogen rotators, two medium V-mirrors, two Z-mirrors
- #5400S Four 360° remote strobe heads, three double V-mirrors, two 2-head strobe packs
- #5401H Two halogen rotators, two fast halogen rotators, two medium V-mirrors, two Z-mirrors, lower LED directional arrow assembly
- #5401S Four 360° remote strobe heads, three double V-mirrors, two 2-head strobe packs, lower LED directional arrow assembly

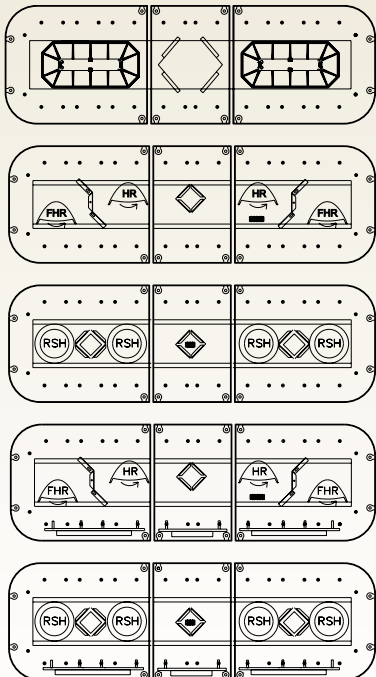

To view all STAR SABRE® LIGHTBARS or request a custom lightbar design kit, please contact us at [www.starheadlight.com](http://www.starheadlight.com)  
SAE Class 1 & California Title 13 approved when properly configured

**ENTORNO INDUSTRIAL, S.A. DE C.V.**

Juan Sarabia No. 205. Col. Nueva Santa Maria. 02800 México, D.F.  
Tels.: (55) 5356-7206 • Fax: (55) 5356-7209

e-mail: [ventas@entorno-industrial.com](mailto:ventas@entorno-industrial.com) • [direccion@entorno-industrial.com](mailto:direccion@entorno-industrial.com)

[www.entorno-industrial.com](http://www.entorno-industrial.com)





# STAR SABRE® LIGHTBARS



## STAR SUPER SABRE™ LIGHTBARS - 46" LED PACKAGES



**5462LED**

Lenses and filters are available in red, blue, amber, green, and clear. A BLACK plastic, low profile, direct roof mount kit is standard and included (820-39-PB). A traffic director control unit is included with lightbars containing a traffic director assembly.

### Standard Models:

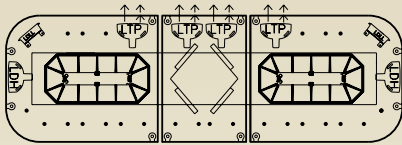

**#5462LED** M-Tech Plus® LED lightbar with 64 LEDs, Four takedown/pursuit lights, two LED intersection clearing lights, two alley lights, two v-mirrors

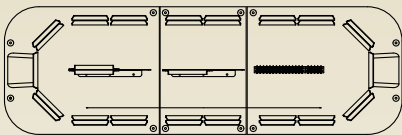

**#5483-\*\*** Twenty Four Batwing Versa Star® DLX6 LEDs, four takedown/pursuit LED lights, two LED alley lights, six head batwing traffic director

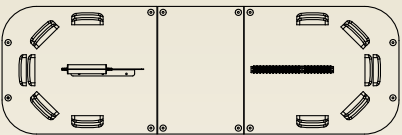

**#5478-\*\*** Twenty Versa Star® DLX6 LEDs

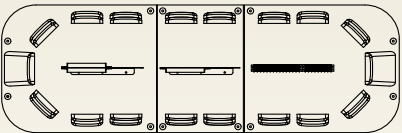

**#5476-\*\*** Thirty Versa Star® DLX6 LEDs, four takedown/pursuit LED lights, two LED alley lights

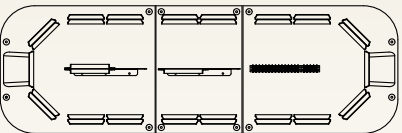

**#5486-\*\*** Thirty Batwing Versa Star® DLX6 LEDs, four takedown/pursuit LED lights, two LED alley lights

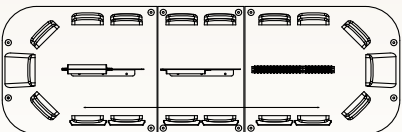

**#5473-\*\*** Twenty Four Versa Star® DLX6 LEDs, four takedown/pursuit LED lights, two LED alley lights

To view all STAR SABRE® LIGHTBARS or request a custom lightbar design kit, please contact us at [www.starheadlight.com](http://www.starheadlight.com)  
SAE Class 1 & California Title 13 approved when properly configured

### ENTORNO INDUSTRIAL, S.A. DE C.V.

Juan Sarabia No. 205. Col. Nueva Santa Maria. 02800 México, D.F.  
Tels.: (55) 5356-7206 • Fax: (55) 5356-7209

e-mail: [ventas@entorno-industrial.com](mailto:ventas@entorno-industrial.com) • [direccion@entorno-industrial.com](mailto:direccion@entorno-industrial.com)

[www.entorno-industrial.com](http://www.entorno-industrial.com)



# STAR SABRE® LIGHTBARS

## STAR SABRE® LIGHTBARS - 56" TOW PACKAGES



5511H

Lenses and filters are available in red, blue, amber, green, and clear. A BLACK plastic, low profile, direct roof mount kit is standard and included (820-39-PB). A traffic director control unit is included with lightbars containing a traffic director assembly.

### Standard Models:

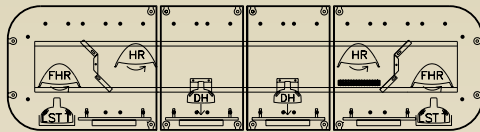

**#5511H** Two halogen rotators, two fast halogen rotators, two Z-mirrors, two rear directional halogen flood lights, two lower stop/turn/tail lights, lower LED directional arrow assembly

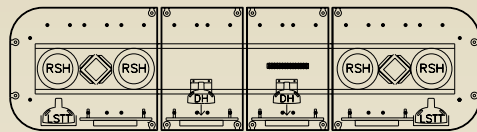

**#5511S** Four 360° remote strobe heads, two double V-mirrors, two rear directional halogen flood lights, two 2-head strobe packs, two lower stop/turn/tail lights, lower LED directional arrow assembly

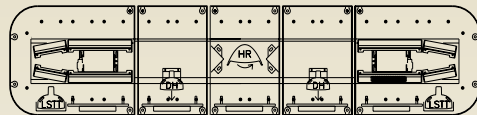

**#5511SL** Four 4.5" linear strobe heads, four 7" linear strobe heads, two 4-head strobe packs, two rear directional halogen flood lights, two lower stop/turn/tail lights, lower LED directional arrow assembly

## STAR SABRE® LIGHTBARS - 66" WARNING PACKAGES



5611H

### Standard Models:



**#5611H** Three halogen rotators, two fast halogen rotators, two Z-mirrors, two small V-mirrors, two rear directional halogen flood lights, two lower stop/turn/tail lights, lower LED directional arrow assembly

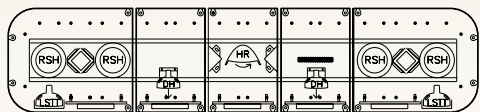

**#5611S** Four 360° remote strobe heads, one halogen rotator, two double V-mirrors, two small V-mirrors, two rear directional halogen flood lights, two 2-head strobe packs, two lower stop/turn/tail lights, lower LED directional arrow assembly

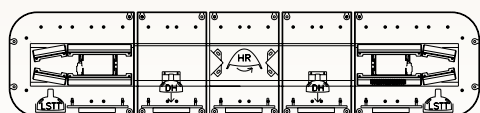

**#5611SL** Four 4.5" linear strobe heads, four 7" linear strobe heads, one halogen rotator, two small V-mirrors, two directional halogen flood lights, two 4-head strobe packs, two lower stop/turn/tail lights, lower LED directional arrow assembly

To view all STAR SABRE® LIGHTBARS or request a custom lightbar design kit, please contact us at [www.starheadlight.com](http://www.starheadlight.com)  
SAE Class 1 & California Title 13 approved when properly configured

### ENTORNO INDUSTRIAL, S.A. DE C.V.

Juan Sarabia No. 205. Col. Nueva Santa María. 02800 México, D.F.  
Tels.: (55) 5356-7206 • Fax: (55) 5356-7209  
e-mail: [ventas@entorno-industrial.com](mailto:ventas@entorno-industrial.com) • [direccion@entorno-industrial.com](mailto:direccion@entorno-industrial.com) • [www.entorno-industrial.com](http://www.entorno-industrial.com)





# STAR INTERCEPTOR® LIGHTBARS

## STAR INTERCEPTOR® LIGHTBARS - 36" EMERGENCY PACKAGES



**8300H**

Lenses and filters are available in red, blue, amber, green, and clear. A BLACK plastic, low profile, direct roof mount kit is standard and included (820-39-PB). A traffic director control unit is included with lightbars containing a traffic director assembly.

### Standard Models:

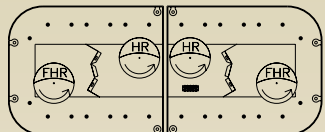

**#8300H** Two halogen rotators, two fast halogen rotators, two lightning mirrors

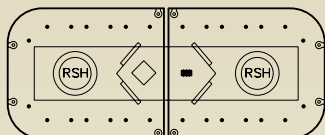

**#8300S** Two 360° remote strobe heads, one 2-head strobe pack, two V-mirrors

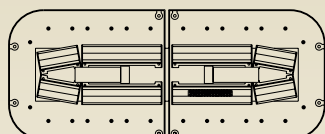

**#8300SL** Four 4.5" linear strobe heads, four 7" linear strobe heads, two 4-head strobe packs

## STAR INTERCEPTOR® LIGHTBARS - 46" EMERGENCY PACKAGES

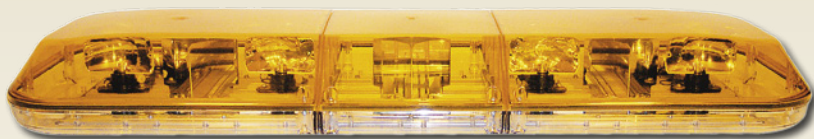

**8400H**

### Standard Models:

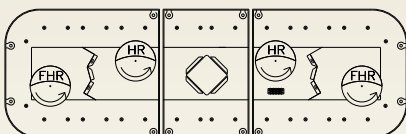

**#8400H** Two halogen rotators, two fast halogen rotators, one double V-mirror, two lightning mirrors

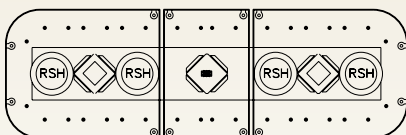

**#8400S** Four 360° remote strobe heads, three double V-mirrors, two 2-head strobe packs

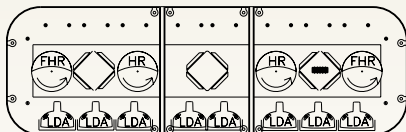

**#8401H** Two halogen rotators, two fast halogen rotators, one double V-mirror, two lightning mirrors, lower directional arrow assembly w/colored lenses

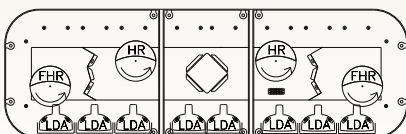

**#8401S** Four 360° remote strobe heads, three double V-mirrors, two 2-head strobe packs, lower directional arrow assembly w/colored lenses

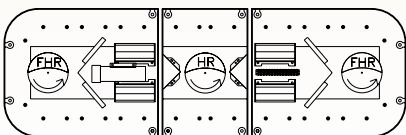

**#8402HSL** One halogen rotator, two fast halogen rotators, two large V-mirrors, two small V-mirrors, four 4.5" linear strobe heads, one 4-head strobe pack

To view all STAR INTERCEPTOR® LIGHTBARS or request a custom lightbar design kit, please contact us at [www.starheadlight.com](http://www.starheadlight.com)  
SAE Class 1 & California Title 13 approved when properly configured

**ENTORNO INDUSTRIAL, S.A. DE C.V.**

Juan Sarabia No. 205. Col. Nueva Santa Maria. 02800 México, D.F.  
Tels.: (55) 5356-7206 • Fax: (55) 5356-7209

e-mail: [ventas@entorno-industrial.com](mailto:ventas@entorno-industrial.com) • [direccion@entorno-industrial.com](mailto:direccion@entorno-industrial.com)

[www.entorno-industrial.com](http://www.entorno-industrial.com)



# STAR INTERCEPTOR® LIGHTBARS

## STAR INTERCEPTOR® LIGHTBARS - 56" TOW PACKAGES



**8521H**

Lenses and filters are available in red, blue, amber, green, and clear. A BLACK plastic, low profile, direct roof mount kit is standard and included (820-39-PB). A traffic director control unit is included with lightbars containing a traffic director assembly.

### Standard Models:

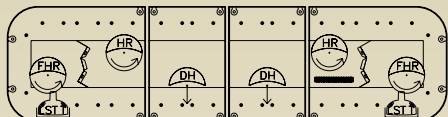

**#8510H** Two halogen rotators, two fast halogen rotators, two lightning mirrors, two rear directional halogen flood lights, two lower stop/turn/tail lights

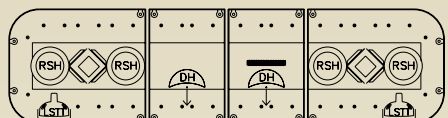

**#8510S** Four 360° remote strobe heads, two double V-mirrors, two rear directional halogen flood lights, two 2-head strobe packs, two lower stop/turn/tail lights



**#8521H** Four fast halogen rotators, two halogen rotators, two lightning mirrors, two wall mirrors, two rear directional halogen flood lights, two lower stop/turn/tail lights, lower directional arrow assembly w/colored lenses

## STAR INTERCEPTOR® LIGHTBARS - 66" TOW PACKAGES

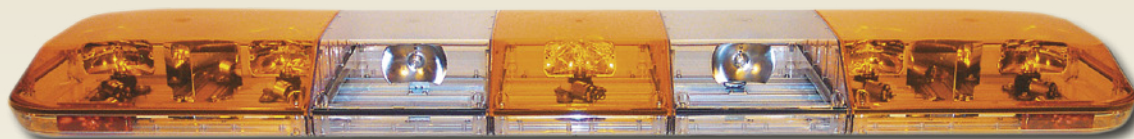

**8610H**

### Standard Models:



**#8610H** Three halogen rotators, two fast halogen rotators, two lightning mirrors, two medium V-mirrors, two lower stop/turn/tail lights, two rear directional halogen flood lights



**#8610S** Four 360° remote strobe heads, one halogen rotator, two double V-mirrors, two medium V-mirrors, two rear directional halogen flood lights, two 2-head strobe packs, two lower stop/turn/tail lights



**#8610SL** Four 4.5" linear strobe heads, four 7" linear strobe heads, one halogen rotator, two medium V-mirrors, two rear directional halogen flood lights, two 4-head strobe packs, two lower stop/turn/tail lights

To view all STAR INTERCEPTOR® LIGHTBARS or request a custom lightbar design kit, please contact us at [www.starheadlight.com](http://www.starheadlight.com)  
SAE Class 1 & California Title 13 approved when properly configured

### ENTORNO INDUSTRIAL, S.A. DE C.V.

Juan Sarabia No. 205. Col. Nueva Santa María. 02800 México, D.F.  
Tels.: (55) 5356-7206 • Fax: (55) 5356-7209  
e-mail: [ventas@entorno-industrial.com](mailto:ventas@entorno-industrial.com) • [direccion@entorno-industrial.com](mailto:direccion@entorno-industrial.com)

[www.entorno-industrial.com](http://www.entorno-industrial.com)





# AEROSTAR® LIGHTBARS

## AEROSTAR® LIGHTBARS - 20" WARNING PACKAGES



6020H

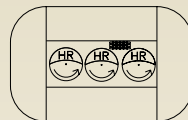
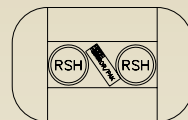
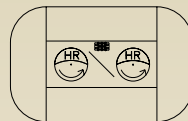
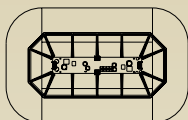

### Standard Models:

- #6032LED** M-Tech Plus® LED lightbar with 32 LEDs, 12" dome section\*  
Available magnetic mount: 6032LEDM  
(includes cig plug with On/Off switch and pattern select switch)
- #6020H** Two halogen rotators, one wall mirror, one 12" dome section\*.  
Available magnetic mount: 6020HM  
(includes cig plug with lighted On/Off switch)
- #6020S** Two 360° remote strobe heads, one wall mirror/strobe pack, one 12" dome section\*.  
Available magnetic mount: 6020SM  
(includes cig plug with lighted On/Off switch)
- #6021H** Three halogen rotators, one 12" dome section\*

## AEROSTAR® LIGHTBARS - 24" WARNING PACKAGES



6222H

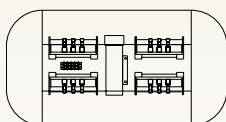
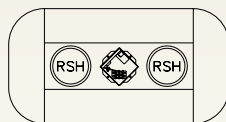

### Standard Models:

- #6222H** Two halogen rotators, one double V-mirror, one 16" dome section\*
- #6222S** Two 360° remote strobe heads, one double V-mirror, one 2-head strobe pack, one 16" dome section\*
- #6224SL** Four 4.5" linear strobe heads, one 4-head strobe pack, one 16" dome section\*

*\*Inserts are only available on 16" dome sections (up to two inserts front and two to the rear)*

Lenses, filters, and inserts are available in red, blue, amber, green, and clear. An aluminum direct roof mount kit is standard and included (920-39). Optional tow mount direct roof mount kit is available as a substitution to the standard kit (920-39T).

To view all AEROSTAR® LIGHTBARS or request a custom lightbar design kit, please contact us at [www.starheadlight.com](http://www.starheadlight.com)  
SAE Class 1 & California Title 13 approved when properly configured

### ENTORNO INDUSTRIAL, S.A. DE C.V.

Juan Sarabia No. 205. Col. Nueva Santa María. 02800 México, D.F.  
Tels.: (55) 5356-7206 • Fax: (55) 5356-7209  
e-mail: [ventas@entorno-industrial.com](mailto:ventas@entorno-industrial.com) • [direccion@entorno-industrial.com](mailto:direccion@entorno-industrial.com) • [www.entorno-industrial.com](http://www.entorno-industrial.com)





# AEROSTAR® LIGHTBARS

## AEROSTAR® LIGHTBARS - 40" WARNING PACKAGES



6304H

### Standard Models:

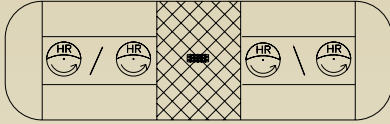

#6304H

Four halogen rotators, two wall mirrors, two 12" dome sections\*

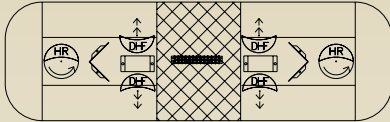

#6308H

Two halogen rotators, two front flashers, two rear flashers, two V-mirrors, two 12" dome sections\*

*Polished stainless steel centerpiece standard; black matte centerpiece optional.*

*\*Inserts are only available on 16" dome sections (up to two inserts front and two to the rear).*

## AEROSTAR® LIGHTBARS - 44" 2 LENS WARNING PACKAGES



6414H

### Standard Models:

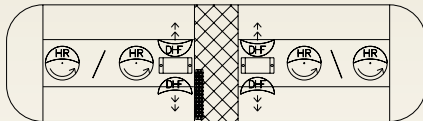

#6414H

Four halogen rotators, two front flashers, two rear flashers, two wall mirrors, two 16" dome sections\*

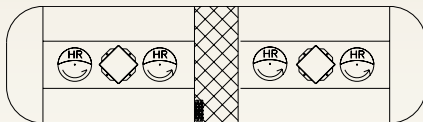

#6444H

Four halogen rotators, two double V-mirrors, two 16" dome sections\*

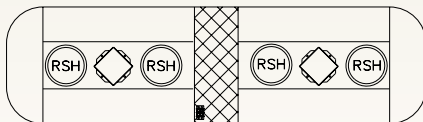

#6444S

Four 360° strobe heads, two 2-head strobe packs, two double V-mirrors, two 16" dome sections\*

*Polished stainless steel centerpiece standard; black matte centerpiece optional.*

*\*Inserts are only available on 16" dome sections (up to two inserts front and two to the rear).*

Lenses, filters, and inserts are available in red, blue, amber, green, and clear. An aluminum direct roof mount kit is standard and included (920-39). Optional tow mount direct roof mount kit is available as a substitution to the standard kit (920-39T).

To view all AEROSTAR® LIGHTBARS or request a custom lightbar design kit, please contact us at [www.starheadlight.com](http://www.starheadlight.com)  
SAE Class 1 & California Title 13 approved when properly configured

**ENTORNO INDUSTRIAL, S.A. DE C.V.**

Juan Sarabia No. 205. Col. Nueva Santa María. 02800 México, D.F.  
Tels.: (55) 5356-7206 • Fax: (55) 5356-7209  
e-mail: [ventas@entorno-industrial.com](mailto:ventas@entorno-industrial.com) • [direccion@entorno-industrial.com](mailto:direccion@entorno-industrial.com)

[www.entorno-industrial.com](http://www.entorno-industrial.com)





## AEROSTAR® LIGHTBARS - 48" WARNING PACKAGES

NEW  
M-Tech Plus™ LED  
Technology



6464LED

### Standard Models:

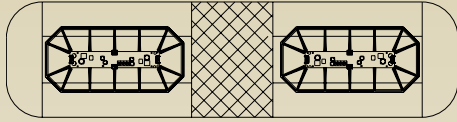

#6464LED

M-Tech Plus® LED lightbar with 64 LEDs.  
two 16" dome sections\*

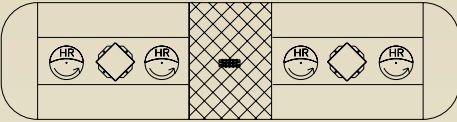

#6420H

Four halogen rotators, two double V-mirrors,  
two 16" dome sections\*

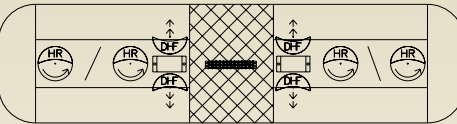

#6448H

Four halogen rotators, two wall mirrors, two front flashers,  
two rear flashers, two 16" dome sections\*

*Polished stainless steel centerpiece standard; black matte centerpiece optional.*

*\*Inserts are only available on 16" dome sections (up to two inserts front and two to the rear)*

## AEROSTAR® LIGHTBARS - 48" 3 LENS WARNING PACKAGES



6423H

### Standard Models:

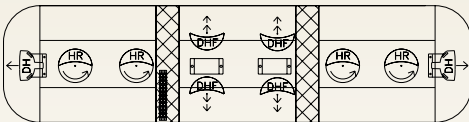

#6423H

Four halogen rotators, two front flashers, two rear flashers,  
two alley lights, three 12" dome sections\*

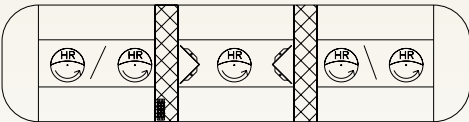

#6430H

Five halogen rotators, two V-mirrors, two wall mirrors,  
three 12" dome sections\*

Lenses, filters, and inserts are available in red, blue, amber, green, and clear. An aluminum direct roof mount kit is standard and included (920-39). Optional tow mount direct roof mount kit is available as a substitution to the standard kit (920-39T).

To view all AEROSTAR® LIGHTBARS or request a custom lightbar design kit, please contact us at [www.starheadlight.com](http://www.starheadlight.com)  
SAE Class 1 & California Title 13 approved when properly configured



# AEROSTAR® LIGHTBAR

## AEROSTAR® LIGHTBARS - 52" WARNING PACKAGES

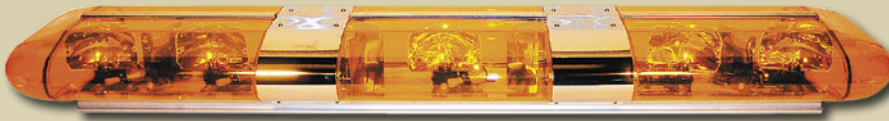

6500H

Lenses, filters, and inserts are available in red, blue, amber, green, and clear. An aluminum direct roof mount kit is standard and included (920-39). Optional tow mount direct roof mount kit is available as a substitution to the standard kit (920-39T).

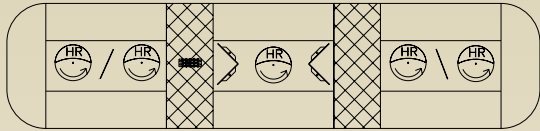

### Standard Models:

**#6500H** Five halogen rotators, two V-mirrors, two wall mirrors, three 12" dome sections\*

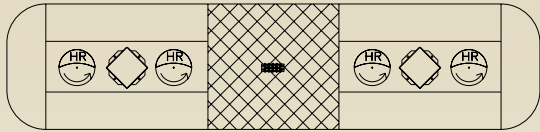

**#6550H** Four halogen rotators, two double V-mirrors, two 16" dome sections\*

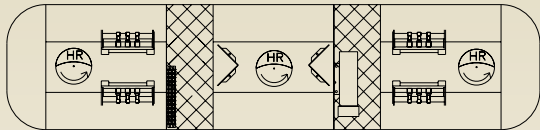

**#6500HSL** Three halogen rotators, four 4.5" linear strobe heads, one 4-head strobe pack, two V-mirrors, three 12" dome sections\*

*Polished stainless steel centerpiece standard; black matte centerpiece optional.*

*\*Inserts are only available on 16" dome sections (up to two inserts front and two to the rear)*



## AEROSTAR® LIGHTBARS - 56" WARNING PACKAGES



6530H

### Standard Models:



**#6564LED** M-Tech Plus® LED lightbar with 64 LEDs, two 16" dome sections\*, one 12" dome section\*

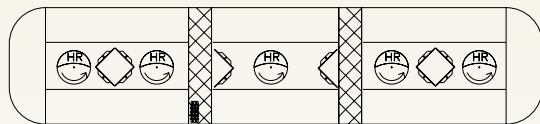

**#6530H** Five halogen rotators, two V-mirrors, two double V-mirrors, two 16" dome sections\*, one 12" dome section\*

*Polished stainless steel centerpiece standard; black matte centerpiece optional.*

*\*Inserts are only available on 16" dome sections (up to two inserts front and two to the rear)*

Lenses, filters, and inserts are available in red, blue, amber, green, and clear. An aluminum direct roof mount kit is standard and included (920-39). Optional tow mount direct roof mount kit is available as a substitution to the standard kit (920-39T).

To view all AEROSTAR® LIGHTBARS or request a custom lightbar design kit, please contact us at [www.starheadlight.com](http://www.starheadlight.com)  
SAE Class 1 & California Title 13 approved when properly configured

### ENTORNO INDUSTRIAL, S.A. DE C.V.

Juan Sarabia No. 205. Col. Nueva Santa María. 02800 México, D.F.  
Tels.: (55) 5356-7206 • Fax: (55) 5356-7209  
e-mail: [ventas@entorno-industrial.com](mailto:ventas@entorno-industrial.com) • [direccion@entorno-industrial.com](mailto:direccion@entorno-industrial.com)

[www.entorno-industrial.com](http://www.entorno-industrial.com)





# AEROSTAR® LIGHTBAR

## AEROSTAR® LIGHTBARS - 56" 3 LENS TOW PACKAGES



6556H

### Standard Models:

#### #6531H

Five halogen rotators, two front flashers, two rear work lights, two V-mirrors, two stop/tail/turn lights, two 16" end dome sections\*, one 12" center dome section\*

#### #6556H

Four halogen rotators, one wall mirror, two front flashers, two stop/tail/turn lights, two 12" dome sections\*, one 16" dome section\*

*Polished stainless steel centerpiece standard; black matte centerpiece optional.*

*\*Inserts are only available on 16" dome sections (up to two inserts front and two to the rear)*

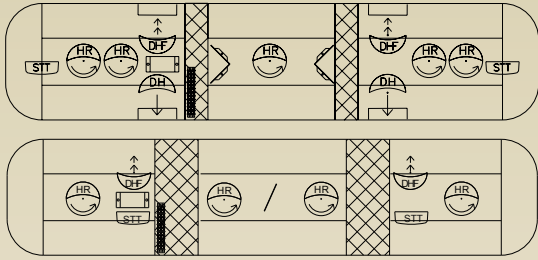

## AEROSTAR® LIGHTBARS - 56" 2 LENS TOW PACKAGES



6511H

### Standard Models:

#### #6511H

Four halogen rotators, two rear work lights, two front flashers, two stop/tail/turn lights, three D.O.T. marker lights, two 16" end dome sections\*

#### #6506H

Two halogen rotators, two V-mirrors, two stop/tail/turn lights, three D.O.T. marker lights, two 16" end dome sections\*

*Polished stainless steel centerpiece standard; black matte centerpiece optional.*

*\*Inserts are only available on 16" dome sections (up to two inserts front and two to the rear)*

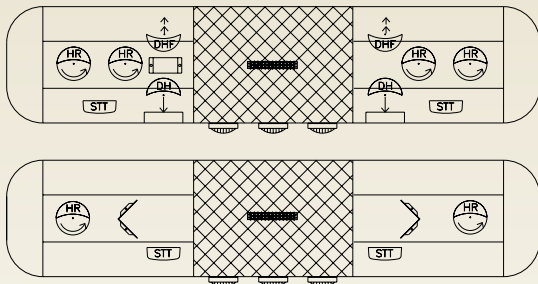

## AEROSTAR® LIGHTBARS - 64" WARNING PACKAGES



6606H

### Standard Models:

#### #6603H

Three halogen rotators, four V-mirrors, six wall mirror array, three 16" dome sections\*

#### #6606H

Six halogen rotators, three double V-mirrors, three 16" dome sections\*

*Polished stainless steel centerpiece standard; black matte centerpiece optional.*

*\*Inserts are only available on 16" dome sections (up to two inserts front and two to the rear)*

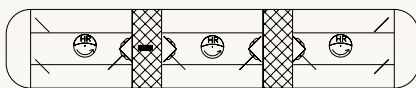

6603H - Three Halogen Rotators, Eight Wall Mirrors, Four Medium V-Mirror, Three 16" Dome Sections

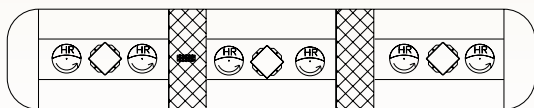

To view all AEROSTAR® LIGHTBARS or request a custom lightbar design kit, please contact us at [www.starheadlight.com](http://www.starheadlight.com)  
SAE Class 1 & California Title 13 approved when properly configured

**ENTORNO INDUSTRIAL, S.A. DE C.V.**

Juan Sarabia No. 205. Col. Nueva Santa Maria. 02800 México, D.F.  
Tels.: (55) 5356-7206 • Fax: (55) 5356-7209

e-mail: [ventas@entorno-industrial.com](mailto:ventas@entorno-industrial.com) • [direccion@entorno-industrial.com](mailto:direccion@entorno-industrial.com)

[www.entorno-industrial.com](http://www.entorno-industrial.com)



# STARBAR® LIGHTBARS

## STARBAR® LIGHTBARS - 36" WARNING PACKAGES



**9300H**

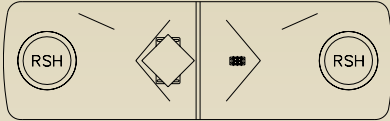
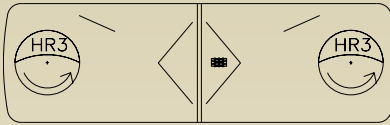

Lenses and filters are available in red, blue, amber, green, and clear. An aluminum direct roof mount kit is standard and included (920-39). Optional tow mount direct roof mount kit is available as a substitution to the standard kit (920-39T).

### Standard Models:

**#9300H** Two Starbeam™ halogen rotators, two V-mirrors, two wall mirrors

**#9300S** Two 360° remote strobe heads, two V-mirrors, two wall mirrors, one 2-head strobe pack

## STARBAR® LIGHTBARS - 48" WARNING PACKAGES



**9404H**

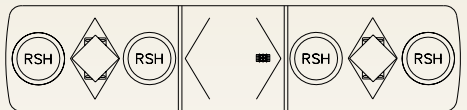
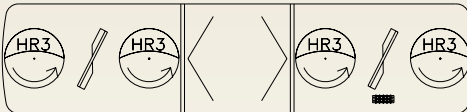

### Standard Models:

**#9400H** Two Starbeam™ halogen rotators, two V-mirrors, two wall mirrors

**#9400S** Two 360° remote strobe heads, two V-mirrors, two wall mirrors, one 2-head strobe pack

**#9404H** Four Starbeam™ halogen rotators, two full size wall mirrors, two large wall mirrors

**#9404S** Four 360° remote strobe heads, two double V-mirrors, two V-mirrors, two 2-head strobe packs

## STARBAR® LIGHTBARS - 58" WARNING PACKAGES



**9500S**

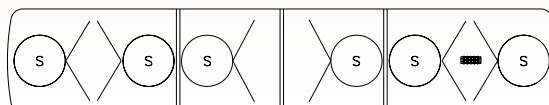
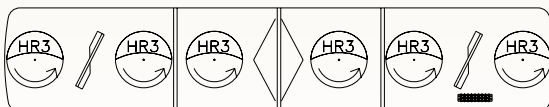

### Standard Models:

**#9500H** Six Starbeam™ halogen rotators, two double V-mirrors, two V-mirrors

**#9500S** Six 360° strobes, two double V-mirrors, two V-mirrors

# STARBAR® LIGHTBARS

## STARBAR® LIGHTBARS - 48" TOW PACKAGES



9411S

### Standard Models:

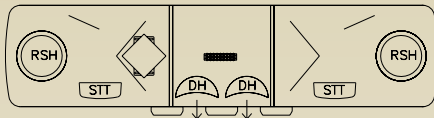

**#9411H** Two Starbeam™ halogen rotators, two V-mirrors, two wall mirrors, two stop/tail/turn lights, three I.D. marker lights, two rear directional halogen flood lights

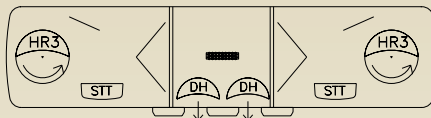

**#9411S** Two 360° remote strobe heads, two V-mirrors, two wall mirrors, two stop/tail/turn lights, three I.D. marker lights, two rear directional halogen flood lights, one 2-head strobe pack

## STARBAR® LIGHTBARS - 58" TOW PACKAGES



9512HS

### Standard Models:

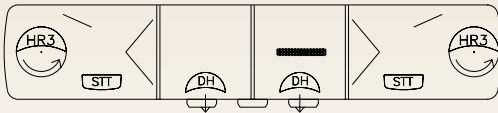

**#9511H** Two Starbeam™ halogen rotators, two V-mirrors, two wall mirrors, two stop/tail/turn lights, three I.D. marker lights, two rear directional halogen flood lights

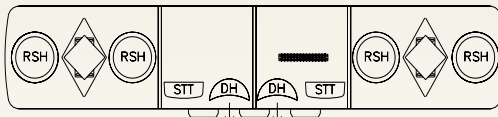

**#9512S** Four 360° remote strobe heads, two double V-mirrors, two stop/tail/turn lights, three I.D. marker lights, two rear directional halogen flood lights, two 2-head strobe packs



**#9512HS** Two halogen rotators, two 360° remote strobe heads, two double V-mirrors, two stop/tail/turn lights, three I.D. marker lights, two rear directional halogen flood lights, one 2-head strobe pack

Lenses and filters are available in red, blue, amber, green, and clear. An aluminum direct roof mount kit is standard and included (920-39). Optional tow mount direct roof mount kit is available as a substitution to the standard kit (920-39T).

To view all STARBAR® LIGHTBARS or request a custom lightbar design kit, please contact us at [www.starheadlight.com](http://www.starheadlight.com)  
SAE Class 1 & California Title 13 approved when properly configured

**ENTORNO INDUSTRIAL, S.A. DE C.V.**

Juan Sarabia No. 205. Col. Nueva Santa Maria. 02800 México, D.F.  
Tels.: (55) 5356-7204 • Fax: (55) 5356-7209  
e-mail: [ventas@entorno-industrial.com](mailto:ventas@entorno-industrial.com) • [direccion@entorno-industrial.com](mailto:direccion@entorno-industrial.com) [www.entorno-industrial.com](http://www.entorno-industrial.com)





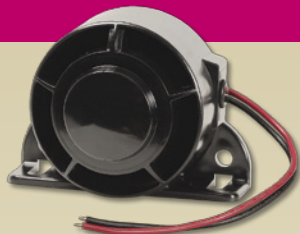

**66 Series Alarm**  
with attached wire leads

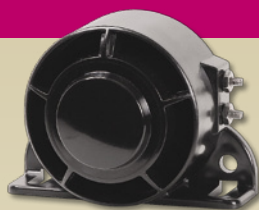

**66 Series Alarm**  
with wire lugs only

**Specifications:**

**Size:** 4-3/16"H x 3-1/16"W x 2"D  
**Weight:** 2 lbs.  
**Amp Draw:** 0.3 Amps  
**Mounting:** Industry Standard

Our 66 Series back-up alarms with CRS Technology™ incorporate a compact rear-facing speaker with a heavy-duty housing to provide one of the most reliable sound chambers in the industry. This design almost completely protects the speaker from the damage often caused by high-pressure spray, dirt, and fine dust!



**62 Series Alarm**  
(Polycarbonate housing)

**60 & 62 Series Specifications:**

**Size:** 3"H x 4-1/2"W x 2"D  
**Weight:** 2 lbs.  
**Amp Draw:** Less than 0.5 Amps  
**Mounting:** 2 holes (3-25/32" centers)



**61 Series Alarm**

**61 Series Specifications:**

**Size:** 4-1/2"H x 6"W x 2-3/8"D  
**Weight:** 4 lbs.  
**Amp Draw:** Less than 0.5 Amps  
**Mounting:** 2 holes (5-1/4" centers)

STAR ALARM® Back-up Alarms are built for long-term reliability, all with a Beep Rate of approximately 60 per minute. They are a convenient compact size available in a range of decibel options perfect for a wide range of vehicle applications.

**Models & Specifications:**

**66 Series Back-Up Alarms w/ attached wire leads**

66-087:	12V - 36V DC	87db
66-097:	12V - 36V DC	97db
66-097-12:	12V DC only	97db
66-102:	12V - 36V DC	102db
66-107-12:	12V DC	107db
66-107-24:	24V-36V	107db

**Dual -Tone**

66-097DT:	12V - 24V DC	97db
66-102DT:	12V DC	102db

**Starmatic Auto-Adjust**

66-707A:	12V - 24V DC	Auto-adjust 77db - 97db
66-802A:	12V - 24V DC	Auto-adjust 82db - 102db
66-807A:	12V DC	Auto-adjust 87db - 107db

**Selectable**

66-802S:	12V - 36V DC	87 or 102db
66-907S:	12V DC	97or 107db

**Dual Function**

66-097DF:	12V - 36V DC	97db
-----------	--------------	------

**Selectable**

66-097SS:	12V - 36V DC	97db
66-092SS:	12V - 36V DC	92db
66-087SS:	12V - 36V DC	87db

**66 Series Back-up Alarms with wire lugs only**

**Single-Tone**

66L-087:	12V - 36V DC	87db
66L-097:	12V - 36V DC	97db
66L-097-12:	12V DC only	97db
66L-102:	12V - 36V DC	102db
66L-107-12:	12V DC	107db
66L-107-24:	24V-36V	107db

**Dual -Tone**

66L-097DT:	12V - 24V DC	97db
66L-102DT:	12V DC	102db

**Starmatic Auto-Adjust**

66L-707A:	12V - 24V DC	Auto-adjust 77db - 97db
66L-802A:	12V - 24V DC	Auto-adjust 82db - 102db
66L-807A:	12V DC	Auto-adjust 87db - 107db

**60 & 62 Series Single-Tone Back-up Alarms**

60-087:	12V - 36V DC	87db
60-097:	12V - 36V DC	97db
60-102:	12V - 36V DC	102db
60-107-12:	12V DC only	107db
60-107-24:	24V - 36V DC	107db
62-087:	12V - 36V DC	87db
62-097:	12V - 36V DC	97db
62-102:	12V - 36V DC	102db
62-107-12:	12V DC only	107db
62-107-24:	24V - 36V DC	107db

**60 & 62 Series Dual-Tone Back-up Alarms**

60-097DT:	12V - 36V DC	97db
60-102DT:	12V DC	102db
62-097DT:	12V - 36V DC	97db
62-102DT:	12V DC	102db

**60 & 62 Series Starmatic™ Auto-Adjust Back-up Alarms**

60-707A:	12V - 24V DC	Auto-adjust 77db - 97db
60-802A:	12V - 24V DC	Auto-adjust 82db - 102db
60-807A:	12V DC	Auto-adjust 87db - 107db
62-707A:	12V - 24V DC	Auto-adjust 77db - 97db
62-802A:	12V - 24V DC	Auto-adjust 82db - 102db
62-807A:	12V DC	Auto-adjust 87db - 107db

**60 & 62 Series Selectable Decibel Back-up Alarms**

60-802S:	12V - 36V DC	Selectable 87db or 102db
60-907S:	12V DC	Selectable 97db or 107db
62-802S:	12V - 36V DC	Selectable 87db or 102db
62-907S:	12V DC	Selectable 97db or 107db

**61 Series Single-Tone Back-up Alarms**

61-107-12:	12V DC Only	107db
61-107-24:	12V - 36V DC	107db
61-112:	12V - 36V DC	112db



# STAR ALARM® BACK-UP ALARMS

## STAR ALARM®



**64 Series Alarm**  
with attached wire leads



**64 Series Alarm**  
with wire lugs only



**64 Series Alarm**  
with wire lugs and self-grounding strap

DK Series Displays for 64 Series Star Alarms.  
Kits include 5 Alarms, Labels,  
and mounting hardware



**DK64 Series** Wall Mount Kit



**DKC64 Series** Counter Display Kit

STAR ALARM® Back-up Alarms are reliable additions to the STAR Alarm series. Choose between 64 series (heavy duty plastic) or 63 series (grommet mount) alarms, all with a Beep Rate of approximately 60 per minute. They are a convenient compact size available in a range of decibel options perfect for a wide range of vehicle applications.

### 64 Series Back-up Alarms with attached wire leads

#### Single-Tone

<b>64-087:</b>	12V - 36V DC	87db
<b>64-097:</b>	12V - 36V DC	97db
<b>64-097-12:</b>	12V DC only	97db
<b>64-102:</b>	12V - 36V DC	102db
<b>64-107-12:</b>	12V DC only	107db
<b>64-107-24:</b>	24V - 36V DC	107db

#### Dual-Tone

<b>64-097DT:</b>	12V - 36V DC	97db
<b>64-102DT:</b>	12V - 36V DC	102db

#### Starmatic Auto-Adjust

<b>64-707A:</b>	12V - 24V DC	Auto-adjust 77db - 97db
<b>64-802A:</b>	12V - 24V DC	Auto-adjust 82db - 102db
<b>64-807A:</b>	12V DC	Auto-adjust 87db - 107db

### 64 Series Back-up Alarms with wire lugs only

#### Single-Tone

<b>64L-097-12:</b>	12V DC only	97db
--------------------	-------------	------

### 64 Series Back-up Alarms with wire lugs and self-grounding strap

#### Single-Tone

<b>64G-087:</b>	12V - 36V DC	87db
<b>64G-097:</b>	12V - 36V DC	97db
<b>64G-097-12:</b>	12V DC only	97db
<b>64G-102:</b>	12V - 36V DC	102db
<b>64G-107-12:</b>	12V DC only	107db
<b>64G-107-24:</b>	24V - 36V DC	107db

#### Dual-Tone

<b>64G-097DT:</b>	12V - 36V DC	97db
<b>64G-102DT:</b>	12V - 36V DC	102db

#### Starmatic Auto-Adjust

<b>64G-707A:</b>	12V - 24V DC	Auto-adjust 77db - 97db
<b>64G-802A:</b>	12V - 24V DC	Auto-adjust 82db - 102db
<b>64G-807A:</b>	12V DC	Auto-adjust 87db - 107db

### Specifications:

<b>Size:</b>	4-1/16"H x 2-5/8"W x 1-5/8"D
<b>Weight:</b>	2 lbs.
<b>Amp Draw:</b>	Less than 0.5 Amps
<b>Mounting:</b>	2 holes (3-25/32" centers)

### Models & Specifications:

#### 63 Series Single-Tone Back-up Alarms

<b>63-087:</b>	12V - 36V DC	87db
<b>63-097:</b>	12V - 36V DC	97db
<b>63-097-12:</b>	12V DC only	97db
<b>63-102:</b>	12V - 36V DC	102db
<b>63-107-12:</b>	12V DC Only	107db
<b>63-107-24:</b>	24V - 36V DC	107db

#### 63 Series Dual-Tone Back-up Alarms

<b>63-097DT:</b>	12V - 36V DC	97db
<b>63-102DT:</b>	12V DC only	102db

### Specifications:

<b>Size:</b>	4-5/16"Dia. x 1-5/8"D
<b>Weight:</b>	2 lbs.
<b>Amp Draw:</b>	0.3 Amps
<b>Mounting:</b>	Requires standard 4-1/2" rubber grommet



**63 Series Alarm**  
Grommet Mount

**ENTORNO INDUSTRIAL, S.A. DE C.V.**

Juan Sarabia No. 205. Col. Nueva Santa María. 02800 México, D.F.  
Tels.: (55) 5356-7206 • Fax: (55) 5356-7209  
e-mail: ventas@entorno-industrial.com • direccion@entorno-industrial.com

www.entorno-industrial.com



# SWITCH PANELS & SWITCH BOXES

## SB4020 & SB4040 SERIES



**SB4020**



**SB4040**



**SB4020T**



**SB4425T**

Use these deluxe switch boxes to control your Star lightbars or any other functions of your choice. The SB4020 Series features all illuminated switches when in use and the legends are backlit for easy nighttime readability. There is one 40 amp circuit, protected by a relay and self-resetting circuit breaker, and five 20 amp circuits which are individually protected by fuses. The SB4040 features a 3-mode progressive, 40 amp (max) switch, and four 20 amp illuminated switches for a total of 7 fuse protected functions. A customer adjustable jumper has been included for the option of separating slide position 1 & 2 to work independently. The SB4425 offers ten lighted rocker switches for maximum flexibility. The SB4040 and SB4020 series are also available with an attached 15' wire harness. Terminal blocks are standard on SB4020T and SB4425T. Ships complete with legends, mounting bracket, hardware, and instructions.

### Models & Specifications:

<b>SB4020:</b>	(1) 40 amp switch, (5) 20 amp switches, 2' wire harness
<b>SB4020-15:</b>	(1) 40 amp switch, (5) 20 amp switches, 15' wire harness
<b>SB4020T:</b>	(1) 40 amp switch, (5) 20 amp switches, nine position terminal block
<b>SB4040:</b>	(4) 20 amp switches, (1) 3-mode 40 amp (max) progressive slide switch, 2' wire harness
<b>SB4040-15:</b>	(4) 20 amp switches, (1) 3-mode 40 amp (max) progressive slide switch, 15' wire harness
<b>SB4425T:</b>	(1) On/Off power switch (switches 2-5), (4) 40 amp switches, (5) 20 amp switches, twelve position terminal block
<b>Size:</b>	2"H x 6"W x 4-3/4"D, SB4020T: 2-1/4"H x 6-1/8"W x 5-1/4"D SB4425T: 2-1/2"H x 6-1/4"W x 7-1/4"D
<b>Weight (All):</b>	5 lbs.

## SB/SP1515 & SB/SP 3015 SERIES



**SB3015**

(bottom side up view)

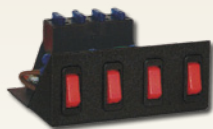

**SP1515**

(bottom side up view)

These switch boxes and switch panels can be mounted under the dash or on the transmission tunnel of the vehicle. The SB1515 and SB3015 are enclosed switch boxes. The SP1515 and SP3015 are not enclosed. All four models have illuminated switching and are equipped with individually fused circuits. Ships complete with instructions.

### Models & Specifications:

<b>SB1515:</b>	Enclosed Switch Box with (4) 20 amp switches
<b>SP1515:</b>	Switch Panel with (4) 20 amp switches
<b>SB3015:</b>	Enclosed Switch Box with (1) 30 amp switch, (3) 20 amp switches
<b>SP3015:</b>	Switch Panel with (1) 30 amp switch, (3) 20 amp switches
<b>Size (All):</b>	2"H x 4-1/2"W x 4"D
<b>Weight (All):</b>	4 lbs.

## SP3860 SERIES - SWITCH PANELS



**SP3860-1**



**SP3860-2**  
**SP3860-2H**

These switch panels can be easily mounted under the dash. All switch panels have illuminated switching and are pre-wired with an in-line fuse for easy installation. Ships complete with labels and instructions.

### Models:

<b>SP3860-1:</b>	On/Off
<b>SP3860-2:</b>	On/Off - On/Off
<b>SP3860-2H:</b>	On/Off - High/Low
<b>SP3860-3:</b>	On/Off - On/Off - On/Off
<b>SP3860-3H:</b>	On/Off - High/Low - On/Off
<b>SP3860-4:</b>	On/Off - On/Off - On/Off - On/Off
<b>SP3860-4H:</b>	On/Off - High/Low - On/Off - On/Off
<b>SP3860-5:</b>	On/Off - On/Off - On/Off - On/Off - On/Off

### ENTORNO INDUSTRIAL, S.A. DE C.V.

Juan Sarabia No. 205. Col. Nueva Santa María. 02800 México, D.F.  
Tels.: (55) 5356-7206 • Fax: (55) 5356-7209  
e-mail: ventas@entorno-industrial.com • direccion@entorno-industrial.com

www.entorno-industrial.com





# STARFLASH™ FLASHER MODULES & HEADS

STARFLASH™



A. HH2501



B HH2502



C. HH3930



D. HH3970

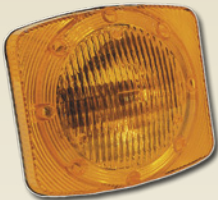

E. HH3971



F. FM3666

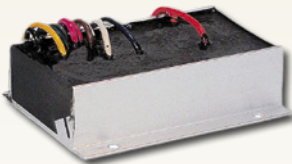

G. FM3669C

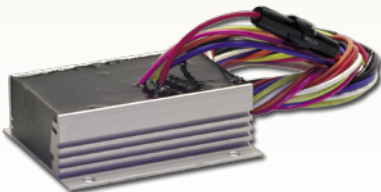

H. DRL366-1

## Models & Specifications:

- A. HH2501** Mini-Rectangular halogen head. grille mount halogen warning light.  
Lens color: Amber, Blue, Clear, Red
- B. HH2502** Rectangular halogen head. grille mount halogen warning light.  
Lens color: Amber, Blue, Clear, Red
- C. HH3930** Par-36 Round sealed beam head. Grille or rear mount halogen warning light with shock-resistant black rubber housing.  
Lens color: Amber, Blue, Clear, Red
- D. HH3970** 7" Diameter sealed beam head:  
For ambulances, fire trucks, rescue vehicles, school buses.  
Lens color: Amber, Blue, Clear, Red
- E. HH3971** 7" Rectangular sealed beam head:  
For ambulances, fire trucks, rescue vehicles  
Lens color: Amber, Blue, Clear, Red
- F. FM3666:** 12V DC Mechanical Flasher.  
**Flash Rate:** 1.2 flashes per second per lamp.
- FM3662:** 12V DC Solid state flasher for up to 100 Watts per side.  
**Flash Rate:** 2.4 flashes per second per lamp.
- FM3662-24:** 24V DC Solid state flasher for up to 100 Watts per side.  
**Flash Rate:** 2.0 flashes per second per lamp.
- FM3667:** 12V DC Solid state flasher for back-up/brake light.  
**Flash Rate:** 2.4 flashes per second per lamp.
- FM3669:** 12V DC Solid state flasher with DRL for up to 100 Watts per side.  
DRL override, night time cut off.  
**Flash Rate:** 1.9 flashes per second per lamp.
- G. FM3669C:** 12V DC Solid state flasher for up to 100 Watts per side.  
Customer selectable flash patterns (Alternating or Simultaneous).  
Night time cut off. Compatible with factory installed DRL control.  
**Flash Rate:** Alternating: 1.9 flashes per second per lamp.  
Simultaneous: 3.6 flashes per second per lamp.
- FM6901:** 12V DC Solid state flasher. Alternately flashes headlights.  
Has high beam override and night time cut off.  
Handles up to 165 watts per output.  
**Flash Rate:** 1.9 flashes per second per lamp.
- FM6902:** 12V DC Solid state flasher. Alternately flashes headlights.  
Has high beam override and night time cut off.  
Handles up to 165 watts per output.  
**Flash Rate:** 2.9 flashes per second per lamp.
- FM6903:** 12V DC Solid state flasher. Simultaneously flashes headlights. Has high beam override and night time cut off. Handles up to 165 watts per output.  
**Flash Rate:** 2.9 flashes per second per lamp.
- FM6904:** Flashes left headlight three times, flashes right headlight three times, then flashes both headlights together three times. Handles up to 165 watts per output.  
**Flash Rate:** 2.9 flashes per second per lamp.
- FM6905:** Ford Crown Victoria Police Package, 2006-current. 12V DC Solid state flasher. Three customer selectable flash patterns. High beam override and night time cut off. Handles up to 55 watts per output. Plug-n-Play  
**Flash Rate:** 1.9, 3.0, or variable 1.9-3.9 flashes per second per lamp. (depending on flash pattern selected)
- FM6906:** Chevrolet Impala Police Package, 2006-current. 12V DC Solid state flasher. Alternately flashes headlights. High beam override. Handles up to 55 watts per output. Plug-n-Play  
**Flash Rate:** 3.0 flashes per second per lamp.
- H. DRL366-1:** Heavy-duty daytime running light module with taillight output, park brake override.

**ENTORNO INDUSTRIAL, S.A. DE C.V.**

Juan Sarabia No. 205. Col. Nueva Santa María. 02800 México, D.F.  
Tels.: (55) 5356-7206 • Fax: (55) 5356-7209  
e-mail: ventas@entorno-industrial.com • direccion@entorno-industrial.com

www.entorno-industrial.com



**ORGANIZERS, BRACKETS & GUARDS**

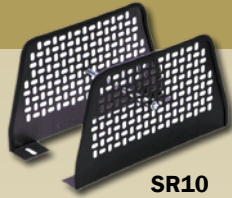

SR10



SR7

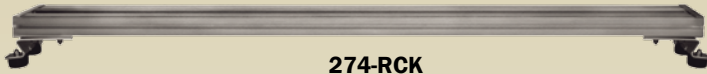

274-RCK

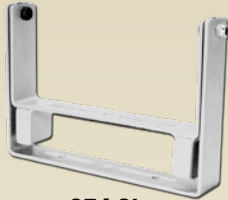

274-SL

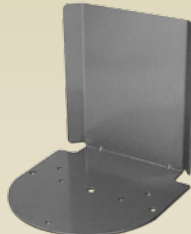

274-LMB



274-SL1



BKT3920



BKT3904



274-40C



274-40S



274-55TC



274-55TS



274-MMB



274-MMBS



274-MMB1T

**Models & Specifications:**

- SR7:** Vertical mount 2 unit organizer  
**Size:** 12-1/2"H x 4-5/16"D  
**Weight:** 2 lbs.
- SR9:** Vertical mount 3 unit organizer  
**Size:** 13-1/2"H x 4-5/16"D  
**Weight:** 2 lbs.
- SR10:** Horizontal mount 3 unit organizer  
**Size:** 7"H x 12"D  
**Weight:** 2.5 lbs.
- SR12:** Horizontal mount 4 unit organizer  
**Size:** 7"H x 14"D  
**Weight:** 2.5 lbs.
- 274-RCK:** Rack for mounting multiple warning lights  
**Size:** Standard 58" length  
**Weight:** 13 lbs.
- 274-SL:** Self-Leveling bracket  
**Size:** 11"H x 4-1/4"D  
**Weight:** 9 lbs.  
**Mounting:** 2 holes on 6-1/4" centers
- 274-SL1:** Self-Leveling bracket for Star Mini-Bars®  
**Size:** 11"H x 4-1/4"D  
**Weight:** 5 lbs.  
**Mounting:** 3 holes on 5-3/4" centers
- 274-LMB:** L-bracket for mirror blockout  
**Size:** 8"H x 8"W x 8"D  
**Weight:** 2 lbs.
- BKT3920:** Steel mount bracket for 6" oval heads
- BKT3904:** Steel mount bracket for 4" round heads
- 274-40C:** Black powder coated steel guard for 6" Lens (Strobe & LED Beacons)
- 274-40S:** Black powder coated steel guard for 4" Lens (Strobe & LED Beacons)
- 274-55TC:** Black powder coated steel guard for 255TC Series 6" Lens (Strobe & LED Beacons)
- 274-55TS:** Black powder coated steel guard for 255TS Series 4" Lens (Strobe & LED Beacons)
- Mirror Mount Brackets:**
- 274-MMB:** 1/2" NPT, 3/4" Post only
- 274-MMBS:** 1/2" NPT, 1-1/4" or 3/4" Posts, Short bracket
- 274-MMBT:** 1/2" NPT, 1-1/4" or 3/4" Posts, Tall bracket
- 274-MMB1S:** 1" NPT, 1-1/4" or 3/4" Posts, Short bracket
- 274-MMB1T:** 1" NPT, 1-1/4" or 3/4" Posts, Tall bracket

## 120BX SERIES - HEAVY DUTY MOUNT BOXES

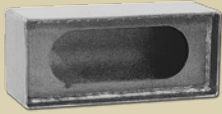

121BX



122BX



123BX

These heavy gauge steel mount boxes are shipped unpainted and ready to weld. Optional self-leveling bracket assembly is available: 274-SBX

### Models & Specifications:

**121BX:** Holds *ONE* 6" oval head:

**Size:** 3-3/4"H x 9"W x 3-1/2"D

**Weight:** 6 lbs.

**122BX:** Holds *TWO* 6" oval heads:

**Size:** 3-3/4"H x 17"W x 3-1/2"D

**Weight:** 9 lbs.

**123BX:** Holds *THREE* 6" oval heads:

**Size:** 3-3/4"H x 25-1/4"W x 3-1/2"D

**Weight:** 12 lbs.

## 130BX & 140BX SERIES - LIGHT DUTY MOUNT BOXES

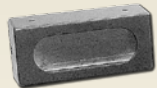

131BX

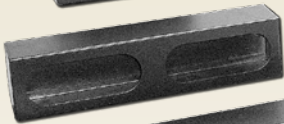

132BX

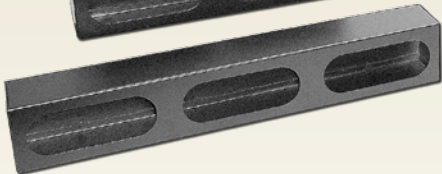

133BX



141BX



142BX

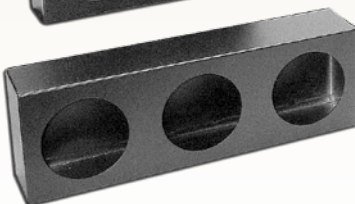

143BX

These light gauge steel mount boxes are shipped painted with knockouts for mounting. Optional self-leveling bracket assembly is available: 274-SBX

### Models & Specifications:

**131BX:** Holds *ONE* 6" oval head:

**Size:** 4"H x 9"W x 3-1/4"D

**Weight:** 2 lbs.

**132BX:** Holds *TWO* 6" oval heads:

**Size:** 4"H x 16-5/8"W x 3-1/4"D

**Weight:** 5 lbs.

**133BX:** Holds *THREE* 6" oval heads:

**Size:** 4"H x 25"W x 3-1/4"D

**Weight:** 8 lbs.

**141BX:** Holds *ONE* 4" round head:

**Size:** 6"H x 6-1/4"W x 3-1/2"D

**Weight:** 2 lbs.

**142BX:** Holds *TWO* 4" round heads:

**Size:** 6"H x 12-1/2"W x 3-1/2"D

**Weight:** 5 lbs.

**143BX:** Holds *THREE* 4" round heads:

**Size:** 6"H x 16-3/4"W x 3-1/2"D

**Weight:** 8 lbs.



# ACCESSORIES

## MISCELLANEOUS

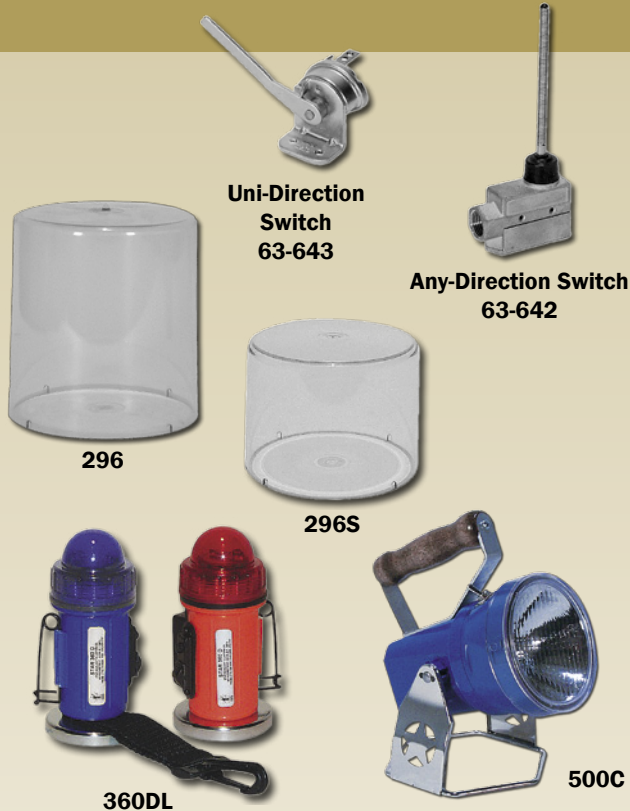

### Models & Specifications:

- 63-643:** Uni-directional switch for Backup Alarms. Activates alarm in one direction only.
- 63-642:** Any-direction switch for Backup Alarms. Spring-level activates alarm in any direction.

Both 63-642 and 63-643 are rated at 16 amps at 12V DC. To be installed adjacent to linkage of gear shift lever.

- 296:** Dust cover for 6" lens (Strobe and LED Beacons)
- 296S:** Dust cover for 4" lens (Strobe and LED Beacons)

### 360D Series Personal Safety LED

Magnetic mount (60 lbs) or clips to belt loop via nylon strap or pins to clothing.

- Output:** 0.130 Watts  
**Weight:** less than 1 lb.  
**Dimensions:** 4-3/4" H x 1-1/2" D

### Specifications:

- Lens color:** (Blue)  
**Case color:** (Blue)

- 500C:** Lantern  
**Size:** 7-1/8"H x 4-3/4"W x 6-3/4"D  
**Weight:** 4 lbs. (with battery)

PARTS		Part #
Incandescent Bulb.....		PR13
Battery.....		8100

## WORK LIGHTS & MAP LIGHTS



PARTS	
Bulb .....	2073-64111

### Models & Specifications:

<b>510:</b>	Clear sealed beam
<b>Weight:</b>	2 lbs.
<b>Output:</b>	3000cp
<b>511:</b>	Sealed beam with lens shield
<b>Weight:</b>	2 lbs.
<b>Output:</b>	3000cp
<b>Lens Colors:</b>	Amber, Blue, Clear, Red
<b>510-4509:</b>	Clear, high intensity, sealed beam
<b>Weight:</b>	2 lbs.
<b>Output:</b>	110,000cp
<b>510-1:</b>	Clear sealed beam with On/Off switch
<b>Weight:</b>	2 lbs.
<b>Output:</b>	3000cp
<b>510-M:</b>	Clear sealed beam with magnet mount and cig plug
<b>Weight:</b>	3 lbs.
<b>Output:</b>	3000cp
<b>510-1M:</b>	Clear sealed beam with magnet mount, cig plug and On/Off switch
<b>Weight:</b>	3 lbs.
<b>Output:</b>	3000cp

<b>511-1M:</b>	Clear sealed beam with magnet mount, cig plug, On/Off switch, and lens shield
<b>Weight:</b>	3 lbs.
<b>Output:</b>	3000cp
<b>Lens Colors:</b>	Amber, Blue, Clear, Red
<b>510-TK:</b>	A complete tow kit that includes two sealed beam lights with red lenses, magnet mount, 30' cable, and connectors all shipped in an enclosed utility box
<b>Kit Weight:</b>	8 lbs.
<b>Output:</b>	3000cp (x2)
<b>Map Lights:</b>	
<b>ML-3:</b>	Lighter plug mount (7" flexible neck)
<b>Size:</b>	12-1/2"H
<b>ML-4:</b>	Permanent mount (4" flexible neck)
<b>Size:</b>	7"H
<b>ML-5:</b>	Permanent mount (18" flexible neck)
<b>Size:</b>	21"H
<b>ML-6:</b>	Permanent mount (10-1/2" flexible neck)
<b>Size:</b>	13"H
<b>Weight:</b>	All less than 1 lb.
<b>Amps:</b>	All 0.5 Amps

## ENTORNO INDUSTRIAL, S.A. DE C.V.

Juan Sorabia No. 205, Col. Nueva Santa María. 02800 México, D.F.  
 Tels.: (55) 5356-7206 • Fax: (55) 5356-7209  
 e-mail: ventas@entorno-industrial.com • direccion@entorno-industrial.com

www.entorno-industrial.com



# STAR LIGHTBARS

## STAR RAZOR®, STAR SABRE®, STAR INTERCEPTOR® LIGHTBAR SPECIFICATIONS

Strobe Pack (2-Head): RP249A-L; 70 Five-flash sequences per minute @ 75 watts (700 FPM)  
 Strobe Pack (4-Head): RP249-L; 70 Five-flash sequences per minute @ 90 watts (1400 FPM)

Model	Voltage	Typical Amp Draw*	Mounting	Dimensions	Shipping Weight
2363LED	12	7.2 (max)	hook-on/permanent	2-3/4" H x 15" W x 36" L	25 lbs.
2300SLD	12	12 (max)	hook-on/permanent	2-3/4" H x 15" W x 36" L	27 lbs.
2300LED	12	14.4 (max)	hook-on/permanent	2-3/4" H x 15" W x 36" L	27 lbs.
2464LED	12	7.2 (max)	hook-on/permanent	2-3/4" H x 15" W x 46" L	31 lbs.
2400SLD	12	19 (max)	hook-on/permanent	2-3/4" H x 15" W x 46" L	36 lbs.
2408LED	12	8.0 (max)	hook-on/permanent	2-3/4" H x 15" W x 46" L	36 lbs.
2410LED	12	17 (max)	hook-on/permanent	2-3/4" H x 15" W x 46" L	39 lbs.
2411LED	12	19.4 (max)	hook-on/permanent	2-3/4" H x 15" W x 46" L	39 lbs.
2464LED-TOW	12	23 (max)	hook-on/permanent	2-3/4" H x 15" W x 46" L	35 lbs.
2500SL	12	26 (max)	hook-on/permanent	2-3/4" H x 15" W x 56" L	45 lbs.
2510SL	12	22 (max)	hook-on/permanent	2-3/4" H x 15" W x 56" L	39 lbs.
2564LED-TOW	12	24 (max)	hook-on/permanent	2-3/4" H x 15" W x 56" L	33 lbs.

Rotators: 520-99; 80fpm (+/-10) standard, 520-99F; 160fpm (+/-10) highspeed  
 Strobe Pack (2-Head): 520-181-SBQ/520-181-SBQ2; 84 Quadflash sequences per minute @ 24 watts (672fpm)  
 Strobe Pack (2-Head): RP248A-L; 70 Five flash sequences per minute @ 75 watts (700fpm)  
 Strobe Pack (4-Head): RP248-L; 70 Five flash sequences per minute @ 90 watts (1400fpm)

Model	Voltage	Typical Amp Draw*	Mounting	Dimensions	Shipping Weight
5300H	12	16	hook-on/permanent	4" H x 15" W x 36" L	25 lbs.
5300S	12	2	hook-on/permanent	4" H x 15" W x 36" L	27 lbs.
5364LED	12	7.2 (max)	hook-on/permanent	4" H x 15" W x 36" L	25 lbs.
5400H	12	16	hook-on/permanent	4" H x 15" W x 46" L	30 lbs.
5400S	12	4	hook-on/permanent	4" H x 15" W x 46" L	35 lbs.
5401H	12	18 (max)	hook-on/permanent	4" H x 15" W x 46" L	32 lbs.
5401S	12	6	hook-on/permanent	4" H x 15" W x 46" L	37 lbs.
5464LED	12	7.2 (max)	hook-on/permanent	4" H x 15" W x 46" L	31 lbs.
5401LED	12	29 (max)	hook-on/permanent	4" H x 15" W x 46" L	33 lbs.
5408LED	12	16.8 (max)	hook-on/permanent	4" H x 15" W x 46" L	30 lbs.
5462LED	12	30 (max)	hook-on/permanent	4" H x 15" W x 46" L	33 lbs.
5411LED	12	31 (max)	hook-on/permanent	4" H x 15" W x 46" L	37 lbs.
5420LED	12	36 (max)	hook-on/permanent	4" H x 15" W x 46" L	42 lbs.
5421LED	12	37 (max)	hook-on/permanent	4" H x 15" W x 46" L	44 lbs.
5511H	12	26 (max)	hook-on/permanent	4" H x 15" W x 56" L	44 lbs.
5511S	12	14 (max)	hook-on/permanent	4" H x 15" W x 56" L	47 lbs.
5511SL	12	28 (max)	hook-on/permanent	4" H x 15" W x 56" L	48 lbs.
5611H	12	30 (max)	hook-on/permanent	4" H x 15" W x 66" L	52 lbs.
5611S	12	18 (max)	hook-on/permanent	4" H x 15" W x 66" L	55 lbs.
5611SL	12	32 (max)	hook-on/permanent	4" H x 15" W x 66" L	56 lbs.

Rotators: 920-99; 80fpm (+/-10) standard, 920-99F; 160fpm (+/-10) highspeed  
 Strobe Pack (2-Head): 620-181-SBQ; 84 Quadflash sequences per minute @ 24 watts (672fpm)  
 Strobe Pack (2-Head): RP249A; 70 Five flash sequences per minute @ 75 watts (700fpm)  
 Strobe Pack (4-Head): RP249; 70 Five flash sequences per minute @ 90 watts (1400fpm)

Model	Voltage	Typical Amp Draw*	Mounting	Dimensions	Shipping Weight
8300H	12	16	hook-on/permanent	5" H x 15" W x 36" L	25 lbs.
8300S	12	2	hook-on/permanent	5" H x 15" W x 36" L	27 lbs.
8300SL	12	17.2	hook-on/permanent	5" H x 15" W x 36" L	32 lbs.
8400H	12	16	hook-on/permanent	5" H x 15" W x 46" L	30 lbs.
8400S	12	7	hook-on/permanent	5" H x 15" W x 46" L	35 lbs.
8401H	12	24 (max)	hook-on/permanent	5" H x 15" W x 46" L	32 lbs.
8401S	12	12	hook-on/permanent	5" H x 15" W x 46" L	37 lbs.
8402HSL	12	21	hook-on/permanent	5" H x 15" W x 46" L	40 lbs.
8510H	12	28 (max)	hook-on/permanent	5" H x 15" W x 56" L	42 lbs.
8510S	12	16 (max)	hook-on/permanent	5" H x 15" W x 56" L	45 lbs.
8521H	12	42 (max)	hook-on/permanent	5" H x 15" W x 56" L	47 lbs.
8610H	12	32 (max)	hook-on/permanent	5" H x 15" W x 66" L	50 lbs.
8610S	12	20 (max)	hook-on/permanent	5" H x 15" W x 66" L	53 lbs.
8610SL	12	34 (max)	hook-on/permanent	5" H x 15" W x 66" L	54 lbs.

\*Amp draw will vary depending on the color of the LED heads used and the flash pattern selected.

### ENTORNO INDUSTRIAL, S.A. DE C.V.

Juan Sarabia No. 205. Col. Nueva Santa María. 02800 México, D.F.  
 Tels.: (55) 5356-7206 • Fax: (55) 5356-7209  
 e-mail: ventas@entorno-industrial.com • direccion@entorno-industrial.com

www.entorno-industrial.com



## STARBAR® & AEROSTAR® LIGHTBAR SPECIFICATIONS

Rotators: 920-99; 80fpm (+/-10) standard, 920-99F; 160fpm (+/-10) highspeed  
 Strobe Pack (2-Head): 620-181-SBQ; 84 Quadflash sequences per minute @ 24 watts (672fpm)  
 Strobe Pack (2-Head): RP248A; 70 Five flash sequences per minute @ 75 watts (700fpm)  
 Strobe Pack (4-Head): RP248; 70 Five flash sequences per minute @ 90 watts (1400fpm)

Model	Voltage	Typical Amp Draw*	Mounting	Dimensions	Shipping Weight
6032LED	12	7.2 (max)	hook-on/permanent	5" H x 12.5" W x 20" L	12 lbs.
6020H	12	8	hook-on/permanent	5" H x 12.5" W x 20" L	12 lbs.
6020S	12	2	hook-on/permanent	5" H x 12.5" W x 20" L	12 lbs.
6021H	12	12	hook-on/permanent	5" H x 12.5" W x 20" L	12 lbs.
6222H	12	8	hook-on/permanent	5" H x 12.5" W x 24" L	15 lbs.
6222S	12	2	hook-on/permanent	5" H x 12.5" W x 24" L	15 lbs.
6224SL	12	9	hook-on/permanent	5" H x 12.5" W x 24" L	17 lbs.
6304H	12	16 (max)	hook-on/permanent	5" H x 12.5" W x 40" L	24 lbs.
6308H	12	20 (max)	hook-on/permanent	5" H x 12.5" W x 40" L	23 lbs.
6414H	12	28 (max)	hook-on/permanent	5" H x 12.5" W x 44" L	26 lbs.
6444H	12	16 (max)	hook-on/permanent	5" H x 12.5" W x 44" L	25 lbs.
6444S	12	4	hook-on/permanent	5" H x 12.5" W x 44" L	27 lbs.
6420H	12	16	hook-on/permanent	5" H x 12.5" W x 48" L	25 lbs.
6464LED	12	7.2 (max)	hook-on/permanent	5" H x 12.5" W x 48" L	25 lbs.
6423H	12	28 (max)	hook-on/permanent	5" H x 12.5" W x 48" L	29 lbs.
6430H	12	20 (max)	hook-on/permanent	5" H x 12.5" W x 48" L	33 lbs.
6448H	12	24 (max)	hook-on/permanent	5" H x 12.5" W x 48" L	25 lbs.
6556H	12	24 (max)	hook-on/permanent	5" H x 12.5" W x 56" L	30 lbs.
6511H	12	34 (max)	hook-on/permanent	5" H x 12.5" W x 56" L	31 lbs.
6506H	12	14 (max)	hook-on/permanent	5" H x 12.5" W x 56" L	27 lbs.
6603H	12	12	hook-on/permanent	5" H x 12.5" W x 64" L	35 lbs.
6606H	12	24	hook-on/permanent	5" H x 12.5" W x 64" L	31 lbs.

Rotators: 920-99; 80fpm (+/-10) standard, 920-99F; 160fpm (+/-10) highspeed  
 Strobe Pack (2-Head): 620-181-SBQ; 84 Quadflash sequences per minute @ 24 watts (672fpm)  
 Strobe Pack (2-Head): RP249A; 70 Five flash sequences per minute @ 75 watts (700fpm)  
 Strobe Pack (4-Head): RP249; 70 Five flash sequences per minute @ 90 watts (1400fpm)

Model	Voltage	Typical Amp Draw*	Mounting	Dimensions	Shipping Weight
9300H	12	8	hook-on/permanent	5" H x 11" W x 36" L	20 lbs.
9300S	12	2.3	hook-on/permanent	5" H x 11" W x 36" L	20 lbs.
9400H	12	8	hook-on/permanent	5" H x 11" W x 48" L	30 lbs.
9400S	12	2.3	hook-on/permanent	5" H x 11" W x 48" L	30 lbs.
9404H	12	16	hook-on/permanent	5" H x 11" W x 48" L	30 lbs.
9404S	12	5	hook-on/permanent	5" H x 11" W x 48" L	30 lbs.
9500H	12	24	hook-on/permanent	5" H x 11" W x 58" L	42 lbs.
9500S	12	12	hook-on/permanent	5" H x 11" W x 58" L	42 lbs.
9411H	12	22 (max)	hook-on/permanent	5" H x 11" W x 48" L	30 lbs.
9411S	12	17 (max)	hook-on/permanent	5" H x 11" W x 48" L	30 lbs.
9511H	12	22 (max)	hook-on/permanent	5" H x 11" W x 58" L	42 lbs.
9512S	12	19 (max)	hook-on/permanent	5" H x 11" W x 58" L	42 lbs.
9512HS	12	25 (max)	hook-on/permanent	5" H x 11" W x 58" L	42 lbs.

\*Amp draw will vary depending on the color of the LED heads used and the flash pattern selected.

### ENTORNO INDUSTRIAL, S.A. DE C.V.

Juan Sarabia No. 205. Col. Nueva Santa María. 02800 México, D.F.  
 Tels.: (55) 5356-7206 • Fax: (55) 5356-7209  
 e-mail: ventas@entorno-industrial.com • direccion@entorno-industrial.com

www.entorno-industrial.com





# STAR LIGHTBARS

## STAR LIGHTBAR HOOK MOUNT KITS

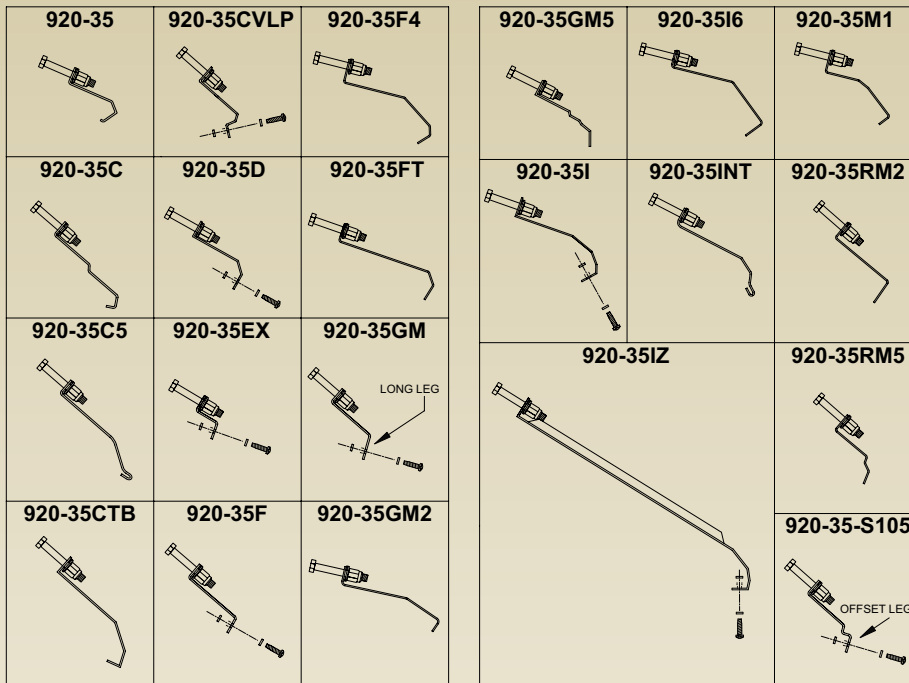

For up to date brackets visit our website [www.starheadlight.com](http://www.starheadlight.com)

## VEHICLE MOUNT APPLICATIONS

Make	Model	Style	Beg. Year	Thru Year	Roof Width	Model #
CHEVROLET	Avalanche	Wrap-around Doors	2002	2010	51"	920-35-S105
CHEVROLET	C/K Pickup 1500	Wrap-around Doors	1999	2007	52"	920-35-S105
CHEVROLET	C/K Pickup 2500, 3500	Wrap-around Doors	2001	2007	52"	920-35-S105
CHEVROLET	Camaro	Standard Roof	1984	1992	48.5"	920-35
CHEVROLET	Camaro	Wrap-around Doors	1993	2002	45.5"	920-35C
CHEVROLET	Caprice	Standard Roof	1988	1996	48.5"	920-35C
CHEVROLET	Caprice	Wrap-around Doors	1988	1996	48.5"	920-35C
CHEVROLET	Caprice	Standard Roof	1977	1990	54.0"	920-35
CHEVROLET	Cavaller Z-24	Standard Roof	1990	1994	45"	920-35
CHEVROLET	Impala	Wrap-around Doors	2000	2005	51"	920-35I
CHEVROLET	Impala	Wrap-around Doors	2006	2010	46.5"	920-35I6
CHEVROLET	Lumina (Sedan)	Wrap-around Doors	1997		47"	920-35GM
CHEVROLET	Lumina (Sedan)	Wrap-around Doors	1998		47"	920-35C
CHEVROLET	R/V Chassis-Cab	Standard Roof	1990	1991	49"	920-35
CHEVROLET	R/V Series Pickup	Standard Roof	1990	1991	59"	920-35
CHEVROLET	S-10 Blazer & Pickup	Wrap-around Doors	1991	1993	47"	920-35GM2
CHEVROLET	Silverado/Sierra	Wrap-around Doors	2001	2010	52"	920-35-S105
CHEVROLET	Suburban	Standard Roof	1990	1991	59"	920-35
CHEVROLET	Suburban	Wrap-around Doors	2000	2006	52"	920-35-S105
CHEVROLET	Suburban	Wrap-around Doors	2007	2010	55"	920-35GM5
CHEVROLET	Tahoe	Wrap-around Doors	2000	2006	52"	920-35-S105
CHEVROLET	Tahoe	Wrap-around Doors	2007	2010	55"	920-35GM5
CHEVROLET	Trailblazer/Envoy	Wrap-around Doors	2002	2005	48"	920-35CTB
CHEVROLET	Trailblazer	Wrap-around Doors	2007	2010	51"	920-35-S105
CHEVROLET	Trucks		1980	1987		920-35C5
CHEVROLET	Trucks		1988	1994		920-35
CHEVROLET	Van (not Astro)	Standard Roof	1988	1995	65"	920-35
CHEVROLET	Van (not Astro)	Wrap-around Doors	1996	2002	65"	920-35INT
DODGE	Caravan/Grand Caravan	Standard Roof	1990	1995	59"	920-35C
DODGE	Charger	Wrap-around Doors	2005	2007	51"	920-35M1
DODGE	Charger	Wrap-around Doors	2008	2010	51"	920-35CH
DODGE	Dakota	Wrap-around Doors	1990	1996	48"	920-35GM2
DODGE	Dakota (Reg, Ext, Crew)	Wrap-around Doors	1997	2010	48"	920-35GM
DODGE	Dakota	Wrap-around Doors	2006	2006	48"	920-35F
DODGE	Durango	Wrap-around Doors	1996	2003	48"	920-35GM
DODGE	Durango	Wrap-around Doors	2004	2009	48"	920-35-S105
DODGE	Intrepid	Wrap-around Doors	1998	2004	46"	920-35GM
DODGE	Intrepid	Standard Roof	1993	1997	48"	920-35INT
DODGE	Magnum	Wrap-around Doors	2005	2008	51"	920-35M1
DODGE	Ram (Quad cab)	Wrap-around Doors	1999	2001	54.5"	920-35GM
DODGE	Ram		1991			920-35
DODGE	Ram		1995			920-35C
DODGE	Ram (Quad cab)	Wrap-around Doors	1999	2001	54.5"	920-35GM
DODGE	Ram (Quad cab)	Wrap-around Doors	2002	2005	54.5"	920-35RM2
DODGE	Ram pickup	Wrap-around Doors	1994	1998	54.5"	920-35CTB
DODGE	Ram pickup		1994	1998		920-35F
DODGE	Ram pickup (Crew)	Wrap-around Doors	2003	2007	48"	920-35RM5

Make	Model	Style	Beg. Year	Thru Year	Roof Width	Model #
DODGE	Ram pickup (Reg)	Wrap-around Doors	2003	2007	48"	920-35RM2
DODGE	Ram (1500, 2500, 3500)	Wrap-around Doors	2008	2010	57.5"	920-35RM3
DODGE	Ram pickup (Reg)	Wrap-around Doors	2003	2007	48"	920-35RM2
FORD	Bronco			1995		920-35F
FORD	Crown Victoria	Wrap-around Doors	1992	2008	46"	920-35CVLP
FORD	Crown Victoria	Wrap-around Doors	1988	1994		920-35C5
FORD	E-Series (Van)	Standard Roof	1987	2007	66"	920-35
FORD	Excursion		2000	2005	57"	920-35GM
FORD	Expedition	Wrap-around Doors	1997	2002	49"	920-35EX
FORD	Expedition	Wrap-around Doors	2003	2010	52"	920-35FT
FORD	Explorer	Wrap-around Doors	2000	2007	49"	920-35D
FORD	Explorer	Wrap-around Doors	2008	2010	51"	920-35D1
FORD	FreeStar	Wrap-around Doors	2005	2007	49.5"	920-35D
FORD	F-Series	Standard Roof	1987	1996	60.5"	920-35
FORD	F-Series	Wrap-around Doors	1997	1997	60.5"	920-35D
FORD	F-Series (150, 250)	Wrap-around Doors	1998	2001	53"	920-35D
FORD	F-Series (150, 250, 450, 550)	Wrap-around Doors	2004	2005	57"	920-35F4
FORD	F-Series (150)	Wrap-around Doors	2007	2010	57"	920-35F1
FORD	F-Series (250, 350, 450)	Wrap-around Doors	2007	2010	58.5"	920-35F2
FORD	F-Series (250)		1991			920-35D
FORD	F-Series (250)		1991			920-35C
FORD	F-Series (250)	Wrap-around Doors	2002	2004	51.5"	920-35FT
FORD	F-Series (250, 350, 450, 550)	Wrap-around Doors	1998	2005	57"	920-35GM
FORD	F-Series (350)		2000			920-35
FORD	LTD-Crown Vic	Standard Roof	1988	1991	51"	920-35
FORD	LTD-Crown Vic		1992	2010	46"	920-35CVLP
FORD	Mustang	Standard Roof	1988	1993	47"	920-35
FORD	Ranger	Standard Roof	1987	1992	52"	920-35
FORD	Ranger		1997			920-35
FORD	Ranger		1999	2000		920-35GM
FORD	Ranger	Wrap-around Doors	2002	2007	48.5"	920-35GM
FORD	Taurus	Wrap-around Doors	2001	2005	47"	920-35GM2
FORD	Van (Full size)		1987	2007	66"	920-35
FORD	Windstar	Wrap-around Doors	1999	2001	49"	920-35GM
GMC	Envoy	Wrap-around Doors	2002	2005	48"	920-35CTB
GMC	Jimmy (full size)	Standard Roof	1990	1991	59"	920-35
GMC	S10 Jimmy & pickup	Wrap-around Doors	1990	1993	47"	920-35GM2
GMC	Trucks		1988	1994		920-35GM
GMC	Trucks		1995	2000		920-35-S105
ISUZU	Delivery Truck Chassis		2000	2004		920-35IZ
JEEP	Jeep Cherokee	Standard Roof	1990	1994	53.5"	920-35
JEEP	Jeep Cherokee	Standard Roof	1995	2001	51.5"	920-35
JEEP	Jeep Grand Cherokee	Wrap-around Doors	1999	2004	48"	920-35GM
JEEP	Jeep Liberty	Wrap-around Doors	2002	2004	46"	920-35GM
PLYMOUTH	PT Cruiser	Wrap-around Doors	2001	2005	44"	920-35GM
PONTIAC	Grand Prix		1994			920-35GM
TOYOTA	Trundra		2004	2004		920-35F

### ENTORNO INDUSTRIAL, S.A. DE C.V.

Juan Sarabia No. 205. Col. Nueva Santa María. 02800 México, D.F.  
 Tels.: (55) 5556-7206 • Fax: (55) 5556-7209  
 e-mail: [ventas@entorno-industrial.com](mailto:ventas@entorno-industrial.com) • [direccion@entorno-industrial.com](mailto:direccion@entorno-industrial.com)

[www.entorno-industrial.com](http://www.entorno-industrial.com)



# STROBE REMOTE KITS & HEADS

## REMOTE POWER SUPPLY SPECIFICATIONS

MODEL NUMBER		RP310D	RP310Q	RP242*	RP244*	RP966*	RP996*
POWER (WATTS)		24	24	40	75	60	90
AMPS	@ 12VDC	2.5	2.5	4.2	7.8	7.8	9.4
	@ 24VDC	1.3	1.3	2.1	3.9	3.1	4.7
JOULES†	PRIMARY	7.8	7.8	3.4	6.4	5.5	8.3
	SECONDARY 1	3.5	3.1	3.4	6.4	3.8	5.7
	SECONDARY 2	N/A	3.1	3.4	6.4	3.8	5.7
	SECONDARY 3	N/A	3.1	3.4	6.4	3.8	5.7
	SECONDARY 4	N/A	N/A	3.4	6.4	3.8	5.7
TOTAL OUTPUT (Joules)		11.3	17.1	17.0	31.9	20.7	31.1
ENERGY EFFICIENCY 80%		80%	80%	80%	80%	80%	75%
NUMBER OF OUTLETS		2	2	2	4	6	6
	Alternating	1 & 2	1 & 2	1 & 2	1&3,2&4	1&2,3&4,5&6	1&2,3&4,5&6
	Simultaneous	N/A	N/A	N/A	1&2,3&4	1,2,3,4,5,6	1,2,3,4,5,6
HIGH/LOW POWER OPTION		YES	YES	YES	YES	YES	YES
HEAD-SWITCHING OPTION							
	SA=Alternating	N/A	N/A	YES	YES	YES	YES
	SS-Simultaneous						
FUSE PROTECTED		N/A	N/A	YES	YES	YES	YES
FLASH RATE		512fpm	672fpm	705fpm	1410fpm	2610fpm	2610fpm
PATTERN SELECT		N/A	N/A	YES	YES	YES	YES
WEATHERPROOF		N/A	N/A	N/A	N/A	N/A	N/A
WEIGHT (lbs.)		1.0	1.0	1.5	1.5	1.3	1.3

\*Specs listed are for the five flash pattern of these remote power supplies. Other patterns are customer selectable.

†One joule assimilates 100,000 candle power.

#All remote strobe paks are reverse polarity protected.

## CABLE SPECIFICATIONS FOR REMOTE POWER SUPPLIES

MODEL NUMBER	LENGTH	LIGHT-DUTY	HEAVY-DUTY	SHIELDED	CONNECTOR PACK SIDE	CONNECTOR HEAD SIDE
4415	15 ft.	X		X	AMP	AMP
4420	20 ft.	X		X	AMP	AMP
4425	25 ft.	X		X	AMP	AMP
4430	30 ft.	X		X	AMP	AMP
3814	specify*		X		AMP	WEATHERPROOF
3820	specify*	X			AMP	WEATHERPROOF
3821	specify*	X			AMP	AMP

\*Available in 5' increments (10'-50')

### ENTORNO INDUSTRIAL, S.A. DE C.V.

Juan Sarabia No. 205. Col. Nueva Santa María. 02800 México, D.F.  
Tels.: (55) 5356-7206 • Fax: (55) 5356-7209  
e-mail: ventas@entorno-industrial.com • direccion@entorno-industrial.com

www.entorno-industrial.com



# AT-A-GLANCE SPECIFICATION CHART FOR BEACONS

## SPECIFICATION CHART

LED BEACONS							
PAGE	WARNING LIGHTS	LENS COLORS	VOLTAGES	MOUNTING	CURRENT DRAW AMPS	OUTPUT	LBS.
2	200AHL	A R B C G	12-24V DC	S (P)	0.6	SAE Class I	4
2	200AH8L	A R B C G	12-24V DC	S (P)	0.6	SAE Class I	4
2	200BHL	A R B C G	12-24V DC	P (S)	0.6	SAE Class I	4
2	200BH8L	A R B C G	12-24V DC	P (S)	0.6	SAE Class I	4
3	200CHL	A R B C G	12-24V DC	S	0.6	SAE Class I	4
3	200CH8L	A R B C G	12, 24V DC	S	0.6	SAE Class I	4
3	200SHL	A R B C G	12-24V DC	S (P,M)	0.6	SAE Class I	3
3	200SH8L	A R B C G	12-24V DC	S (P,M)	0.6	SAE Class I	3
4	240H8AL	A R B C G	12, 24V DC	S (P,M)	0.6	SAE Class I, CA Title 13	3
4	240HCL	A R B C G	12-24V DC	S (P,M)	0.6	SAE Class I	3
4	240H8CL	A R B C G	12-24V DC	S (P,M)	0.6	SAE Class I	3
4	240HSL	A R B C G	12-24V DC	S (P,M)	0.6	SAE Class II	2
4	240H8SL	A R B C G	12-24V DC	S (P,M)	0.6	SAE Class I	2
5	255H8TAL	A R B C G	12-24V DC	S (P,M)	0.6	SAE Class I, CA Title 13	3
5	255HTCL	A R B C G	12-24V DC	S (P,M)	0.6	SAE Class I	3
5	255HTSL	A R B C G	12-24V DC	S (P,M)	0.6	SAE Class II	2
6	200ZL	A	12-16V DC	S (P,M)	0.35	SAE Class III	2
6	201ZL	A	12-16V DC	S (P,M)	0.35	SAE Class III	2
6	203MVL	A	12-16V DC	S (P,M)	0.35	SAE Class III	1
6	204MVL	A	12-16V DC	S	0.35	SAE Class III	1
STROBE BEACONS							
7	200A	A R B C G M	12, 24, 36, 48, 72V DC	S (P)	2.0	10	4
7	200AD,Q†	A R B C G M	12, 24V DC, 110/120V AC	S (P)	2.0	15.5, 17.6	4
7	200B	A R B C G M	12, 24, 36, 48, 72V DC, 110/120V AC,	P (S)	2.0	10	4
7	200BD,Q†	A R B C G M	12, 24V DC, 110/120V AC	P (S)	2.0	15.5, 17.6	4
7	200C	A R B C G M	12, 24, 36, 48, 72V DC	S	2.0	10	4
7	200CD,Q†	A R B C G M	12, 24V DC	S	2.0	15.5, 17.6	4
9	200S	A R B C G M	12, 24, 36, 48, 72V DC, 110/120V AC	S (P,M)	2.0	8	3
9	200SD,Q†	A R B C G M	12, 24V DC	S (P,M)	2.0	15.5, 17.6	3
12	200Z,Q	A R B C G M	12, 24, 36V DC, 110/120V AC	S (P,M)	.5	3, 3.75	2
12	201Z,Q	A R B C G M	12, 24, 36V DC, 110/120V AC	S (P,M)	.5	3, 3.75	2
13	203MV	A R B C G M	12V through 72V DC	S (P,M)	1.5	1.5	1
13	204MV	A R B C G M	12-110V DC	S	.5	1.75	1
11	211RQ	A R B C G M	12V DC	S (M)	.5	3.75	3
10	240C	A R B C G M	12, 24, 36-48V DC	S (P,M)	2.0	8	3
10	240CD,Q†	A R B C G M	12, 24V DC	S (P,M)	2.0	15.5, 17.6	3
10	240S	A R B C G M	12, 24, 36, 48V DC	S (P,M)	2.0	8	2
10	240SD,Q†	A R B C G M	12, 24V DC	S (P,M)	2.0	15.5, 17.6	2
11	241SFQ†	A R B C G M	12,24V DC	S (P,M)	2.0	17.6	2
10	242CL	A R B C G M	12V through 24V DC	S (P,M)	2.0	19.5	3
10	242SL	A R B C G M	12V through 24V DC	S (P,M)	2.0	19.5	2
8	250ADH,QH†	A R B C G M	12, 24V DC	S	3.2	23	5
8	250CH	A R B C G M	12, 24V DC	S	3.6	20	5
8	250CDH,QH†	A R B C G M	12, 24V DC	S	3.2	23	5
8	250SH	A R B C G M	12, 24V DC	S	3.6	20	5
8	250SDH,QH†	A R B C G M	12, 24V DC	S	3.2	23	5
8	255HTC	A R B C G M	12V through 24V DC	S (P,M)	2.0	19.5	3
9	255TC	A R B C G M	12V through 48V DC	S (P,M)	1.15	7, 10	3
9	255TS	A R B C G M	12V through 24V DC	S (P,M)	1.15	7, 10	2

†HIGH/LO  
Feature

Amber, Red, Blue  
Clear, Green, Magenta

Current Draw Based on 12.8V DC  
unless otherwise noted  
\*Based on 110/120V AC

S=Permanent surface  
P=Pipe M=Magnetic

Note: Not all models are listed in this section. Please refer to catalog pages for specifications not listed here.  
All strobes are rated at a nominal 65 flash sequences per minute unless otherwise noted in catalog.

### ENTORNO INDUSTRIAL, S.A. DE C.V.

Juan Sarabia No. 205. Col. Nueva Santa Maria. 02800 México, D.F.  
Tels.: (55) 5356-7206 • Fax: (55) 5356-7209  
e-mail: ventas@entorno-industrial.com • direccion@entorno-industrial.com

www.entorno-industrial.com





# STROBE TUBE & BULB GUIDE

## STROBE TUBES

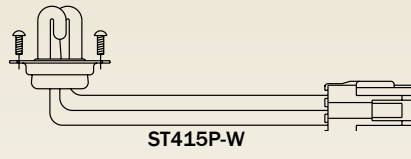
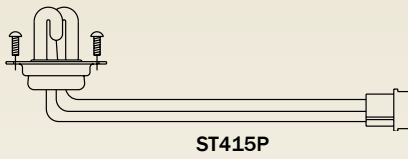
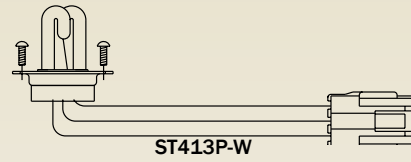
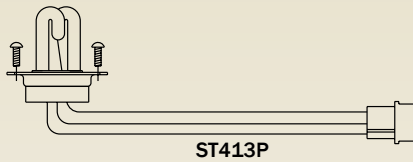
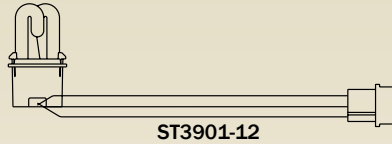
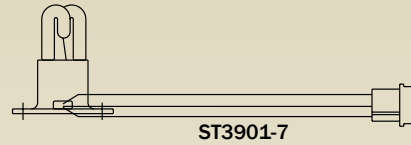
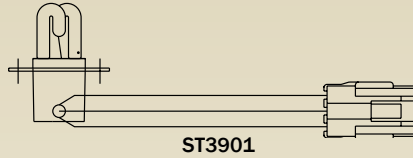
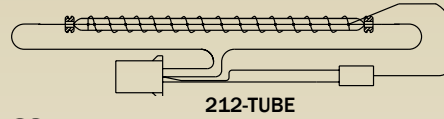
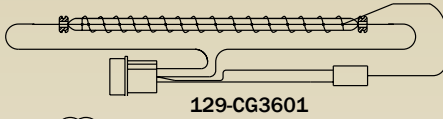
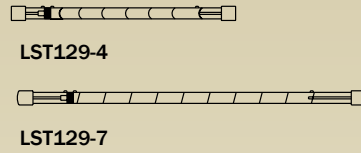
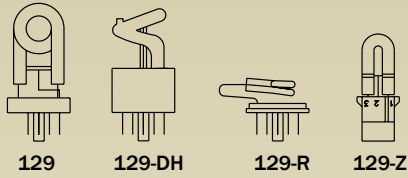

## BULBS

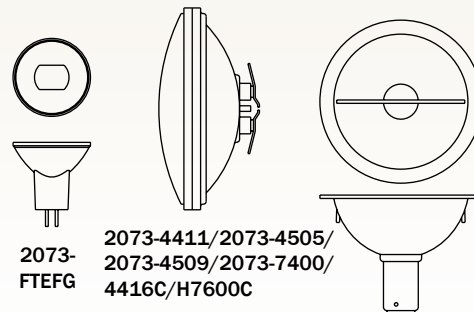
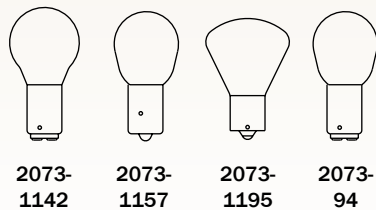
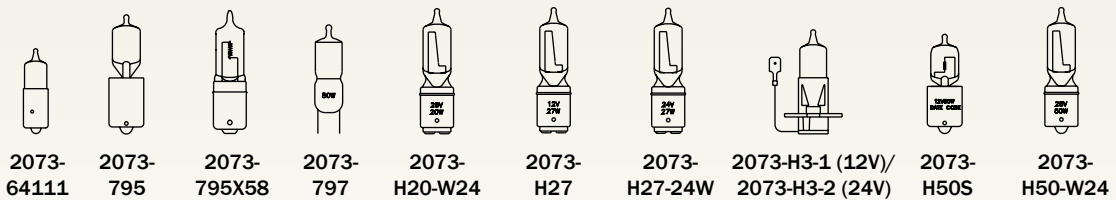

### ENTORNO INDUSTRIAL, S.A. DE C.V.

Juan Sarabia No. 205. Col. Nueva Santa María. 02800 México, D.F.  
 Tels.: (55) 5356-7206 • Fax: (55) 5356-7209  
 e-mail: ventas@entorno-industrial.com • direccion@entorno-industrial.com

www.entorno-industrial.com



1166HM, 1166IM, 1169H.....	17	255H8TCL, 255H8TCLV.....	6	66L-087, 66L-097, 66L-097-12.....	56	LDHEF-4, LDHEF-6, LDHEF-3.....	25
1169HM, 1188H, 1188HM.....	17	255HTSL, 255HTSLV.....	6	66L-102, 66L-107.....	56	LDHEF-3K, LDHEF-4MR.....	25
121BX, 122BX, 123BX.....	60	255H8TSL, 255H8TSLV.....	6	66L-707A, 66L-802A, 66L-807A.....	56	LDK302, LDK304.....	26
131BX, 132BX, 133BX.....	60	257H8TALV, 257H8TAL.....	6	6020H, 6020S, 6021H.....	48	LDK312, LDK314.....	26
141BX, 142BX, 143BX.....	60	257HTCL, 257HTCLV.....	6	6032LED.....	48	LDHF301, LDHF311.....	26
20FI, 20FI-1.....	18	257H8TCL, 257H8TCLV.....	6	622H, 6222S, 6224SL.....	48	ML-3, ML-4, ML-5, ML-6.....	61
20RH, 20RHM, 20RI, 20RIM.....	15	257HTSL, 257HTSLV.....	6	6304H, 6308H, 6414H.....	49	PAR 36.....	25
20ZI, 20ZIM, 21ZI, 21ZIM.....	18	257H8TSL, 257H8TSLV.....	6	6444H, 6444S.....	49	RP242, RP244.....	29
200A, 200ADH, 200AQH.....	8	258HTDCL, 258HTDSL.....	3	6420H, 6448H.....	50	RP310D, RP310Q.....	29
200AHL, 200AHL.....	2	274-DLX4-6-H, 274-DLX4-6-RL.....	21	6423H, 6430H.....	50	RP966, RP996.....	29
200A1HL, 200A1H8L.....	2	274-DLX4-6-T, 274-DLX4-6-U.....	21	6464LED.....	50	RSK242P, RSK244P.....	27
200B, 200BDH, 200BQH.....	8	274-DLX4-6-W, 274-DLX4-6-45.....	21	6500H, 6550H, 6500HSL.....	51	RSK310P.....	28
200BHL, 200BHL.....	2	274-DLX4-6-1X2.....	21	6530H.....	51	RSK966P, RSK996P.....	28
200C, 200CF.....	8	274-DLX4-6-2X1.....	21	6531H, 6556H, 6511H.....	52	STAR LASER LIGHTBAR.....	40
200CHL, 200CH8L.....	4	274-DLXT-D, 274-DLXT-RL.....	19	6506H, 6603H, 6606H.....	52	SB1515, SP1515.....	57
200CFHL, 200CFH8L.....	4	274-DLXT-T, 274-DLXT-U.....	19	6564LED.....	51	SB3015, SP3015.....	57
200E.....	8	274-DLXT-W, 274-DLXT-45.....	19	735-F, 735FI, 735FI-PC.....	19	SB4020, SB4020-15, SB4020T.....	57
200J, 200J-1, 200JQ, 200JQ-1.....	15	274-DLXT-1X2, 274-DLXT-2X1.....	19	735P-F, 735-SB, 735-P-SB.....	19	SB4040, SB4040-15, SB4425T.....	57
200S, 200SM.....	10	274-40C, 274-40S.....	59	735PS.....	15	SH3904, SH3920.....	30
200SHL, 200SH8L.....	4	274-55TC, 274-55TS.....	59	747, 747-PC, 747LED.....	19	SH3930, SH3930E, SH3940.....	30
200SHLM, 200SH8LM.....	4	274-874, 274-875, 274-878.....	17	845S, 845SQ.....	15	SH3970, SH3922.....	30
200Z, 200ZM.....	13	274-LMB, 274-MMB.....	59	8300H, 8300S, 8300SL.....	46	SH4500, SH4501.....	30
200ZL, 200ZLM, 200ZL-48.....	7	274-MMBS, 274MMBT.....	59	8400H, 8400S, 8401H.....	46	SH4601, SH4602.....	30
200ZQ, 200ZMQ.....	13	274-MMB1S, 274MMB1T.....	59	8401S, 8402HSL.....	46	ST413P, ST415P.....	27, 30
203MV.....	14	274-RCK.....	59	8510H, 8510S, 8521H.....	47	SP3860-1.....	57
203MVL, 203MVL, 203MVL-48.....	7	274-SL, 274-SL1.....	59	8610H, 8610S, 8610SL.....	47	SP3860-2, SP3860-2H.....	57
204MV.....	14	296, 296S.....	61	9016LED, 9016LEDM.....	36	SP3860-3, SP3860-3H.....	57
204MVL, 204MVL-48.....	7	360D-S.....	61	9016LEDV.....	36	SP3860-4, SP3860-4H.....	57
201Z, 201ZM.....	13	400A, 400B.....	16	9100LED.....	37	SP3860-5.....	57
201ZL, 201ZLM, 201ZL-48.....	7	450A, 450AH.....	16	9200HL, 9200HLM, 9200HLV.....	37	SR7, SR9.....	59
201ZQ, 201ZMQ.....	13	450B, 450BH, 455BH.....	16	9200H8L, 9200H8LM.....	37	SR10, SR12.....	59
211R, 211RM.....	12	500C.....	61	9200H8LV.....	37	TD92, TD93, TD93DLXT.....	31
211RQ, 211RMQ.....	12	510, 511, 510-4509.....	61	9200H, 9200HM.....	38	TD93DLXTARO.....	31
2300SL, 2378.....	41	510-1, 510-M, 510-1M.....	61	9200HV, 9200IV.....	38	TD93DLXTARO2.....	31
2364LED, 2464LED.....	41	511-1M, 510-TK.....	61	9200I, 9200IM.....	38	TD93DLXTARO-S.....	31
2464LED-TOW.....	42	5300H, 5300S.....	43	9200S, 9200SM.....	38	TD93DLXTARO-S.....	31
2400SL, 2478.....	41	5364LED, 5464LED.....	43	9200SQ, 9200SMQ.....	38	TDDL15-42CV.....	32
2472, 2476.....	42	5462LED.....	44	9200SV, 9200SQV.....	38	TDDL15-42TA.....	32
2510SL.....	42	5483, 5478, 5476, 5486, 5473.....	44	9216H, 9216S.....	39	TCS-1, TCS-1REF.....	33
2564LED-TOW, 2576LED-TOW.....	42	5400H, 5400S, 5401H, 5401S.....	46	9224H, 9224S.....	39	TCS-2, TCS-2REF, TCS-6.....	33
240C, 240CF, 240CM.....	11	5511H, 5511S, 5511SL.....	45	9300H, 9300S.....	53	ULB9, ULB9S.....	24
240H8AFL, 240H8AFL1.....	5	5611H, 5611S, 5611SL.....	45	9400H, 9400S.....	53	ULB42, ULB42-DLP.....	34
240H8AL, 240H8AL1.....	5	60-087, 60-097.....	55	9404H, 9404S.....	53	ULB10, ULB21, ULB42.....	34
240H8ALM.....	5	60-097DT, 60-102DT.....	55	9411H, 9411S.....	54	ULB14, ULB24.....	35
240HCFL, 240HCFL1.....	5	60-102, 60-107-12, 60-107-24.....	55	9500H, 9500S.....	53	ULB44, ULB44-DLP.....	35
240HCL, 240HCL1.....	5	60-707A, 60-802A.....	55	9511H, 9512S.....	54	ULB42-TD, ULB44-TD.....	33
240HCLM.....	5	60-802S, 60-907S.....	55	9512HS.....	54	VL22.....	36
240H8CFL, 240H8CFL1.....	5	60-807A, 62-707A.....	55	BKT3904, BKT3920.....	59		
240H8CL, 240H8CL1.....	5	61-107-12, 61-107-24.....	55	DK64, DKC64.....	56		
240H8CLM.....	5	61-112.....	55	DL15-6, DL15-6W.....	23		
240S, 240SF, 240SM.....	11	62-087, 62-097.....	55	DL15-6W-1K.....	23		
240HSFL, 240HSFL1.....	5	62-097DT, 62-102DT.....	55	DL15-12, DL15-12W.....	23		
240HSL, 240HSL1.....	5	62-102, 62-107-12, 62-107-24.....	55	DL15-6GMB, DL15-6MMB.....	23		
240HSLM.....	5	62-802A, 62-807A.....	55	DL15-30W.....	32		
240H8SFL, 240H8SFL1.....	5	62-802S, 62-907S.....	55	DL35-6, DL35-6-1.....	22		
240H8SL, 240H8SL1.....	5	63-087, 63-097, 63-097-12.....	56	DL35-12, DL35-12-1.....	22		
240H8SLM.....	5	63-102, 63-107-12, 63-107-24.....	56	DLX3.....	22		
241S, 241SF, 241SM.....	12	63-097DT, 63-102DT.....	56	DLX4, DLX4C, DLX4W.....	21		
242CL, 242CF, 242CLM.....	11	63-642, 63-643.....	61	DLX4-HK, DLX4-HK-1.....	21		
242SL, 242SFL, 242SLM.....	11	64-087, 64-097, 64-097-12.....	56	DLX4-HK2, DLX4-HK2-1.....	21		
250A, 250C, 250S.....	9	64-102, 64-107-12, 64-107-24.....	56	DLX6, DLX6C, DLX6W.....	21		
250AH, 250ADH, 240AQH.....	9	64-097DT, 64-102DT.....	56	DLX6-HK, DLX6-HK-1.....	21		
240ADHP.....	9	64-707A, 64-802A, 64-807A.....	56	DLX6-HK2, DLX6-HK2-1.....	21		
250CH, 250CDH, 240CQH.....	9	64L-097-12.....	56	DLXT, DLHT, DLNT, DLTT.....	20		
250CDHP.....	9	64G-087, 64G-097.....	56	DRL366-1.....	58		
250SH, 250SDH, 250SQH.....	9	64G-097-12.....	56	FM3662, FM3662-24.....	58		
250SDHP.....	9	64G-102, 64G-107-12.....	56	FM3666, FM3667.....	58		
251HTL, 251H8TL.....	3	64G-107-24.....	56	FM3669, FM3669C.....	58		
255HTC, 255HTCM.....	9	64G-097DT, 64G-102DT.....	56	FM6901, FM6902.....	58		
255TC, 255TCM, 255TCV.....	10	64G-707A, 64G-802A, 64G-807A.....	56	FM6903, FM6904.....	58		
255TS, 255TSM, 255TSV.....	10	66-087, 66-097, 66-097-12.....	56	FM6905, FM6906.....	58		
255H8TALV, 255H8TAL.....	6	66-102, 66-107.....	56	HH2501, HH2502.....	58		
255HTCL, 255HTCLV.....	6	66-707A, 66-802A, 66-807A.....	56	HH3930, HH3970, HH3971.....	58		

## ENTORNO INDUSTRIAL, S.A. DE C.V.

Juan Sarabia No. 205. Col. Nueva Santa María. 02800 México, D.F.  
 Tels.: (55) 5356-7206 • Fax: (55) 5356-7209  
 e-mail: ventas@entorno-industrial.com • direccion@entorno-industrial.com

www.entorno-industrial.com



# STAR QUALITY CONTINUES TO SHINE INTO THE NEW MILLENNIUM



## ***“123 Years and We’re Still On Track For You!”***

*STAR Warning Systems continues to lead the Amber Warning Light Industry!*

Our main production facility located in the Finger Lakes Region of Upstate New York continues to expand. This “state of the art” facility accommodates all of our in-house electronic and finished product assembly along with plastic injection molding, metal fabrication, product engineering, warehousing, shipping, customer service, sales, and technical support. Having all of these functions under one roof gives us the capability to engineer, build, expedite, and ship your product more efficiently. In the last three years we have added SMT circuit production technology to our list of manufacturing expertise. This new production department will allow us to more efficiently maintain our leadership role in LED warning light technology.

Our ISO 9001:2008 Certification and its ongoing programs continue to stress our commitment to quality and customer service. We are determined to increase our industry advantage in providing you with the best and most reliable vehicular warning systems.



STAR’s “Yes The U.S.” logo is a symbol of our dedication to manufacture products made in the USA, assuring you of the highest quality available anywhere in the world.

In the beginning of 2012 Star Headlight & Lantern Co., Inc. decided to change the name of Signal Vehicle Products® to StarSignal™ to carry on the “Star” name.

Since 1889, Star Headlight & Lantern Co., Inc., and our family of dedicated employees have brought superior quality, service, and customer commitment to a level unmatched in the industry. Today and into the future, we will continue to meet your needs with the same enthusiasm for which we have become known for over the last 123 years.

We hope you will enjoy this new catalog and its expanded product line. You can also visit us and examine products on our new website at [www.starheadlight.com](http://www.starheadlight.com).

We look forward to working with you and we realize that our customers are our most valuable asset.





# STAR WARNING SYSTEMS®

Distributed By:



**ENTORNO  
INDUSTRIAL**

## **ENTORNO INDUSTRIAL, S.A. DE C.V.**

Juan Sarabia No. 205. Col. Nueva Santa María. 02800 México, D.F.

Tels.: (55) 5356-7206 • Fax: (55) 5356-7209

e-mail: [ventas@entorno-industrial.com](mailto:ventas@entorno-industrial.com) • [direccion@entorno-industrial.com](mailto:direccion@entorno-industrial.com) • [www.entorno-industrial.com](http://www.entorno-industrial.com)



**PROUDLY MADE IN THE U.S.A**  
*An ISO 9001:2008 Certified Company*

**STAR HEADLIGHT & LANTERN CO., INC.**  
**455 Rochester Street • Avon, NY 14414**  
**Phone: (585) 226-9500**  
**Fax: (888) 478-2797 or (585) 226-2029**

[www.entorno-industrial.com](http://www.entorno-industrial.com)